

HF12XA-5M

Technical Datasheet

2/3"

FUJINON
FUJIFILM



Fujinon HF-XA-5M Series

ORDER NOW 

Fujifilm's Fujinon HF-XA-5M series lenses offer a 3.45 μ m resolving power (equivalent to 5.0 megapixels) and are designed for use with 2/3" and smaller sensors. The HF-XA-5M series is available in 7 variants from 6 mm to 50 mm and feature Fujinon's 4DHR technology which allow them to provide highly consistent image sharpness across both the center and outer extremities of the lens.

Specification Highlights

FOCAL LENGTH: 12 mm
FORMAT: 2/3"
PIXEL SIZE: 3.45 μ m
LENS MOUNT: C-Mount
APERTURE: F1.6-F16

WORKING DISTANCE: 100mm - Infinity
FILTER THREAD: M25.5 x 0.5
WEIGHT: 79 grams
RESOLUTION MP: 5 MP
LENS CLASS: Fixed Focal Length

Full Specifications

Focal Length	12 mm	Flange Back	17.526 mm
Focal Length Design Value	12.4 mm	Entrance Pupil Position (From Mount)	-35.54 mm
Iris Range (f-number)	F1.6-F16	Exit Pupil Position (From Image Plane)	-123.16 mm
Angle of View	40.1° x 30.3° (2/3")	Front Principal Point (From Mount)	-24.44 mm
Working Distance (From Front of Lens Barrel)	100 mm - Infinity	Rear Principal Point (From Mount)	5.13 mm
Operation of Focus	Manual	Distance Between Principal Points	29.57 mm
Operation of Iris	Manual	TV Distortion	-1.26%
Filter Thread	M25.5 x 0.5	Dimensions	φ29.5 × 51.5
Mount	C-Mount	Chief Ray Angle	2.06°
Weight	79 Grams	Relative Illumination (Aperture F4.0; Image Height at Diagonal)	93%
Sensor Size (Standard)	2/3" (3.45 μm)	Relative Illumination (Aperture at Full Open; Image Height at Diagonal)	45%
Back Focal Length (In Air)	11.89 mm	Operation Temperature	-10°C - +50°C

Dimensions

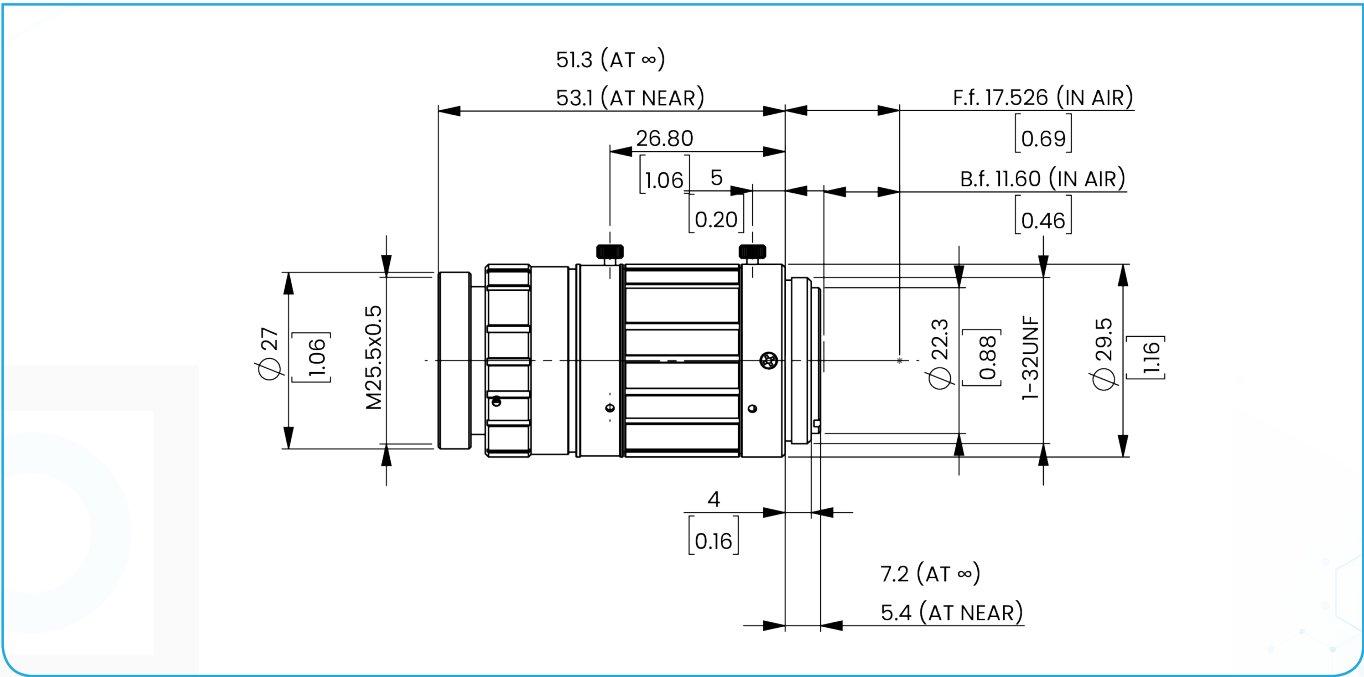

HF12XA-5M REFERENCE FOV CHART

Working Distance (mm)	Optical Magnification	Extension Ring	Field of View (mm)															
			1.1"		1"		1/1.2"		2/3"		1/1.8"		1/2"		1/2.5"		1/3"	
			H	V	H	V	H	V	H	V	H	V	H	V	H	V	H	V
1000	0.012x	-	-	-	-	-	912.8	673.5	740.3	548.8	593.5	441.6	531.7	396.2	472.1	352.6	396.2	296.0
950	0.013x	-	-	-	-	-	867.8	640.3	703.8	521.7	564.3	419.9	505.5	376.6	448.8	335.3	376.6	281.4
900	0.014x	-	-	-	-	-	822.8	607.1	667.4	494.7	535.0	398.1	479.3	357.1	425.5	317.9	357.1	266.8
850	0.014x	-	-	-	-	-	777.8	573.9	630.9	467.6	505.8	376.3	453.0	337.6	402.3	300.5	337.6	252.2
800	0.015x	-	-	-	-	-	732.8	540.7	594.4	440.6	476.5	354.6	426.8	318.1	379.0	283.1	318.1	237.7
750	0.016x	-	-	-	-	-	687.9	507.5	557.9	413.5	447.3	332.8	400.6	298.5	355.7	265.7	298.5	223.1
700	0.017x	-	-	-	-	-	642.9	474.3	521.4	386.5	418.0	311.0	374.4	279.0	332.5	248.4	279.0	208.5
650	0.019x	-	-	-	-	-	597.9	441.1	484.9	359.4	388.8	289.3	348.2	259.5	309.2	231.0	259.5	193.9
600	0.020x	-	-	-	-	-	552.9	407.9	448.4	332.4	359.5	267.5	322.0	240.0	285.9	213.6	240.0	179.3
550	0.022x	-	-	-	-	-	507.9	374.7	411.9	305.4	330.2	245.7	295.8	220.4	262.7	196.2	220.4	164.7
500	0.024x	-	-	-	-	-	462.9	341.5	375.5	278.3	301.0	224.0	269.6	200.9	239.4	178.8	200.9	150.1
450	0.027x	-	-	-	-	-	418.0	308.3	339.0	251.3	271.7	202.2	243.4	181.4	216.1	161.5	181.4	135.5
400	0.030x	-	-	-	-	-	373.0	275.2	302.5	224.2	242.5	180.4	217.2	161.9	192.9	144.1	161.9	120.9
350	0.034x	-	-	-	-	-	328.0	242.0	266.0	197.2	213.2	158.7	191.0	142.3	169.6	126.7	142.3	106.3
300	0.039x	-	-	-	-	-	283.0	208.8	229.5	170.1	184.0	136.9	164.8	122.8	146.3	109.3	122.8	91.8
250	0.047x	-	-	-	-	-	238.0	175.6	193.0	143.1	154.7	115.1	138.6	103.3	123.1	91.9	103.3	77.2
200	0.058x	-	-	-	-	-	193.0	142.4	156.5	116.0	125.5	93.4	112.4	83.8	99.8	74.5	83.8	62.6
150	0.075x	-	-	-	-	-	148.1	109.2	120.0	89.0	96.2	71.6	86.2	64.2	76.5	57.2	64.2	48.0
100	0.108x	-	-	-	-	-	103.1	76.0	83.6	61.9	67.0	49.8	60.0	44.7	53.3	39.8	44.7	33.4

FOV Charts are intended to be used as general guidance and are not guaranteed to be accurate as all sensors do not have the same dimensions, including sensors with the same format size. For the most accurate approximations, please use a lens calculator that accounts for your specific sensor dimensions

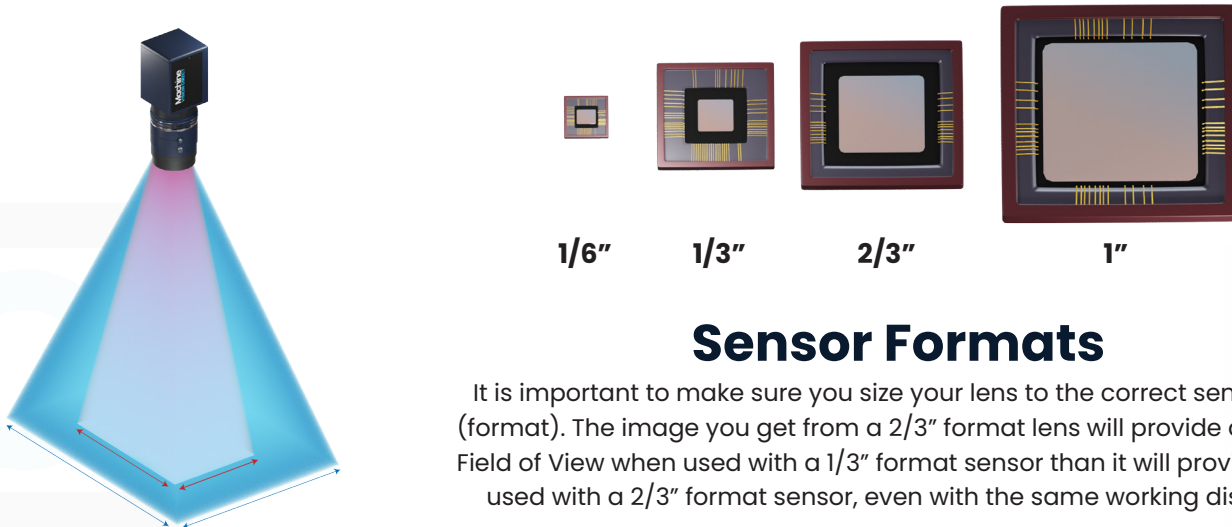

1/6"

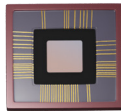
1/3"

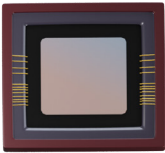
2/3"

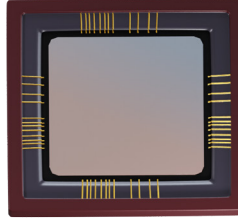
1"

Sensor Formats

It is important to make sure you size your lens to the correct sensor size (format). The image you get from a 2/3" format lens will provide a smaller Field of View when used with a 1/3" format sensor than it will provide when used with a 2/3" format sensor, even with the same working distance

Sensor Size Compatibility Chart

Model	Compatible format sizes								Focal length (mm)
	4/3	1.1	1	1/1.2	2/3	1/1.8	1/2	1/3	
HF6XA-5M	-	-	-	-	•	•	•	•	6
HF8XA-5M	-	-	-	-	•	•	•	•	8
HF12XA-5M	-	-	-	○	•	•	•	•	12
HF16XA-5M	-	-	-	○	•	•	•	•	16
HF25XA-5M	-	-	-	○	•	•	•	•	25
HF35XA-5M	-	-	-	○	•	•	•	•	35
HF50XA-5M	-	○	○	○	•	•	•	•	50

- Compatible sensor size (std.): Ideal size to maximize the target resolution.
- Compatible sensor size (max.): Adaptable sensor size varies depending on the model. Select a lens after checking the peripheral light amount and resolution.

Please note that not all sizes of sensors are listed on this chart. It is generally okay to use larger format lenses with smaller format sensors, but not the other way around

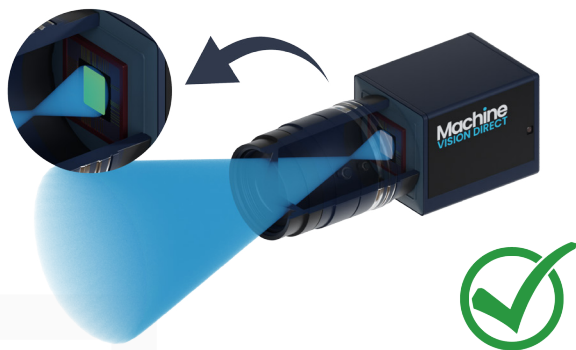

Properly Sized Lens Format

A camera with a properly sized lens will project an image that will cover the whole sensor

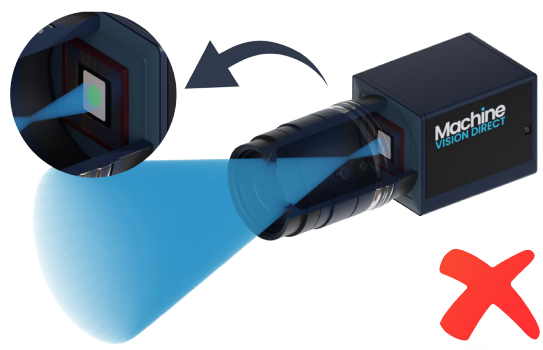

Undersized Lens Format

A camera with an undersized lens format will project an image that will not cover the whole sensor. This will cause vignetting of the image

HF-XA-5M SERIES LENSES



HF6XA-5M

FOCAL LENGTH: 6 mm
APERTURE: F1.9-F16
WORKING DISTANCE: 100 mm - Infinity
FORMAT: 2/3"
FILTER THREAD: M37.5 x 0.5

ORDER NOW 



HF8XA-5M

FOCAL LENGTH: 8 mm
APERTURE: F1.6-F16
WORKING DISTANCE: 100 mm - Infinity
FORMAT: 2/3"
FILTER THREAD: M25.5 x 0.5

ORDER NOW 



HF12XA-5M

FOCAL LENGTH: 12 mm
APERTURE: F1.6-F16
WORKING DISTANCE: 100 mm - Infinity
FORMAT: 2/3"
FILTER THREAD: M25.5 x 0.5

ORDER NOW 



HF16XA-5M

FOCAL LENGTH: 16 mm
APERTURE: F1.6-F16
WORKING DISTANCE: 100 mm - Infinity
FORMAT: 2/3"
FILTER THREAD: M25.5 x 0.5

ORDER NOW 



HF25XA-5M

FOCAL LENGTH: 25 mm
APERTURE: F1.6-F16
WORKING DISTANCE: 100 mm - Infinity
FORMAT: 2/3"
FILTER THREAD: M25.5 x 0.5

ORDER NOW 



HF35XA-5M

FOCAL LENGTH: 35 mm
APERTURE: F1.9-F16
WORKING DISTANCE: 200 mm - Infinity
FORMAT: 2/3"
FILTER THREAD: M25.5 x 0.5

ORDER NOW 



HF50XA-5M

FOCAL LENGTH: 50 mm
APERTURE: F2.4-F16
WORKING DISTANCE: 200 mm - Infinity
FORMAT: 2/3"
FILTER THREAD: M30.5 x 0.5

ORDER NOW 

FUJINON LENS SERIES



HF-HA-1S

FOCAL LENGTH: 6 mm, 9 mm, 12.5 mm
 16 mm, 25 mm, 35 mm
 50 mm, 75 mm

PIXEL SIZE: 6.2 μm

FORMAT: 2/3"

RESOLUTION: 1.5 MP

[VIEW SERIES](#)



HF-SA

FOCAL LENGTH: 12.5 mm, 16 mm, 25 mm
 35 mm, 50 mm, 75 mm

PIXEL SIZE: 3.45 μm

FORMAT: 2/3"

RESOLUTION: 5 MP

[VIEW SERIES](#)



HF-XA-5M

FOCAL LENGTH: 6 mm, 8 mm, 12 mm
 16 mm, 25 mm
 35 mm, 50 mm

PIXEL SIZE: 3.45 μm

FORMAT: 2/3"

RESOLUTION: 5 MP

[VIEW SERIES](#)



HF-XA-1F

FOCAL LENGTH: 8 mm, 12 mm, 16 mm
 25 mm, 35 mm

PIXEL SIZE: 3.45 μm

FORMAT: 2/3"

RESOLUTION: 5 MP

[VIEW SERIES](#)



HF-12M

FOCAL LENGTH: 8 mm, 12 mm, 16 mm
 25 mm, 35 mm

PIXEL SIZE: 2.1 μm

FORMAT: 2/3"

RESOLUTION: 12 MP

[VIEW SERIES](#)



CF-ZA-1S

FOCAL LENGTH: 8 mm, 12 mm, 16 mm
 25 mm, 35 mm, 50 mm

PIXEL SIZE: 2.74 μm

FORMAT: 1.1"

RESOLUTION: 23 MP

[VIEW SERIES](#)



CF-HA

FOCAL LENGTH: 12.5 mm, 16 mm, 25 mm
 35 mm, 50 mm, 75 mm

PIXEL SIZE: 7.4 μm

FORMAT: 1"

RESOLUTION: 1.5 MP

[VIEW SERIES](#)



FE185

FOCAL LENGTH: 6 mm, 9 mm, 12.5 mm
 16 mm, 25 mm, 35 mm
 50 mm, 75 mm

PIXEL SIZE: 6.2 μm

FORMAT: 2/3"

RESOLUTION: 1.5 MP

[VIEW SERIES](#)

Company and product names mentioned in this datasheet are trademarks or registered trademarks of their respective owners.

Fujifilm, Fujinon, Machine Vision Direct, LLC and all of the subsidiaries and parent companies of the aforementioned companies cannot be held responsible for any technical or typographical errors and reserve the right to make changes to products and documentation without prior notice

Revision 6/11/2023