

### Product Highlights

- The RL127 is characterized as a Large High Dispersion Bright Field ring light.
- Non-lensed LEDs disperse light at broad angles, providing "soft" lighting for applications that require short to medium working distances.

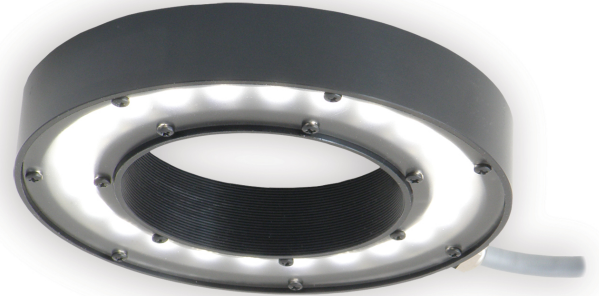

### General Specifications

|                              | Color   | 24V Current | All Other Controls |
|------------------------------|---|-------------|--------------------|
| Electrical Specifications    | 365, 375, 385, 395, 405   | 0.48A       | 0.48A Max          |
|                              | 455, 470, 530, WHI  | 0.48A       | 0.48A Max          |
|                              | 590, 625  | 0.24A       | 0.50A Max          |
|                              | 850, 940  | 0.48A       | 0.60A Max          |
| Normal Operating Temperature | 0 - 60°C  |             |                    |
| Weight                       | 308g (10.9)   |             |                    |
| Standard Cable Information   | 2 m long -0/+150 mm (80" -0/+6") - 105°C rated PVC jacket, foil shield with drain.  |             |                    |
| Photobiological Risk Factor  | Exempt Applicable Wavelengths: 850, 940<br>Group 1 (Low-Risk) Applicable Wavelengths: 455, 470, 530, 590, 625, WHI<br>Group 2 (Moderate-Risk) Applicable Wavelengths: 365, 375, 385, 395, 405 |             |                    |
| Compliance                   | CE, RoHS, IEC 62417   |             |                    |
| IP Rating                    | IP67  |             |                    |
| Lumen Maintenance            | L70 = 50,000 Hours  |             |                    |

## Part Number Key

| Model            | — | Peak Wavelength  | Connector/Control | Light Conditioning Option | — | Alternative Connector |
|------------------|---|--|-------------------|---------------------------|---|-----------------------|
| RL127            | - | XXX  | XX                | X                         | - | XXX                   |
| RL127            |   | 395 (UV)   | C1                | D <sup>2</sup>            |   | M8 <sup>1</sup>       |
|                  |   | 375 (UV)   | C5                | (Diffuser)                |   | M12 <sup>1</sup>      |
|                  |   | 385 (UV)   | IC                | P <sup>2</sup>            |   |                       |
|                  |   | 395 (UV)   | I3                | (Polarizer)               |   |                       |
|                  |   | 405 (violet)   | I3S               |                           |   |                       |
|                  |   | 455 (royal blue)   | 24                |                           |   |                       |
|                  |   | 470 (blue)   |                   |                           |   |                       |
|                  |   | 530 (green)  |                   |                           |   |                       |
|                  |   | 590 (amber)  |                   |                           |   |                       |
|                  |   | 625 (red orange)   |                   |                           |   |                       |
|                  |   | 850 (IR)   |                   |                           |   |                       |
|                  |   | 940 (IR)   |                   |                           |   |                       |
|                  |   | WHI (white)  |                   |                           |   |                       |
| EX:              |   | <sup>1</sup> Available with IC, I3, I3S, and 24 V options only                               |                   |                           |   |                       |
| RL127-470C5D     |   | <sup>2</sup> Not available with UV options; 470 (blue) will reduce the life of the polarizer |                   |                           |   |                       |
| RL127-WHI24P-M12 |   |  |                   |                           |   |                       |

See website product page for in-stock product numbers.

### Shipping:

Stock Products: within three days

Build-to-Order Products: within one to three weeks

### Standard Flying Lead Functions for 24V, IC, I3 and I3S Control Options

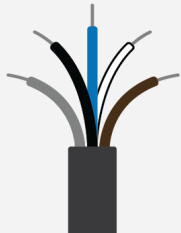
|  | COLOR | 24V FUNCTIONS | IC FUNCTIONS          | I3/I3S FUNCTIONS        |
|---|-------|---------------|-----------------------|-------------------------|
|   | BROWN | 24 V DC       | 24 V DC               | 24 V DC                 |
|   | WHITE | N/A           | 0-10 V ANALOG DIMMING | RESERVED                |
|   | BLUE  | DC GND        | DC GND                | DC GND                  |
|   | BLACK | N/A           | PNP/ACTIVE LOW GATE   | PNP/ACTIVE HIGH TRIGGER |
|   | GRAY  | N/A           | N/A                   | 0-10 V ANALOG DIMMING   |

The functions listed above are applicable when this product is configured with built-in 24V, IC, I3, or I3S control, **without** the optional A-coded 5-position Male M12 or A-coded 4-position Male M8 connector.

### M12 Connector Pinout Functions for 24V, IC, I3 and I3S Control Options

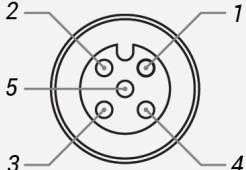
|  | PIN | 24V FUNCTIONS | IC FUNCTIONS          | I3/I3S FUNCTIONS        |
|--|-----|---------------|-----------------------|-------------------------|
|  | 1   | 24 V DC       | 24 V DC               | 24 V DC                 |
|  | 2   | N/A           | 0-10 V ANALOG DIMMING | RESERVED                |
|  | 3   | DC GND        | DC GND                | DC GND                  |
|  | 4   | N/A           | PNP/ACTIVE LOW GATE   | PNP/ACTIVE HIGH TRIGGER |
|  | 5   | N/A           | N/A                   | 0-10 V ANALOG DIMMING   |

The functions listed above are only applicable when this product is configured with built-in 24V, IC, I3, or I3S control, **with** an A-coded 5-position Male M12 connector.

### M8 Connector Pinout Functions for 24V, IC, I3 and I3S Control Options

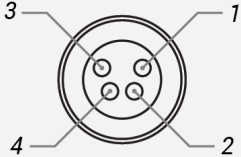
|  | PIN | 24V FUNCTIONS | IC FUNCTIONS          | I3/I3S FUNCTIONS        |
|---|-----|---------------|-----------------------|-------------------------|
|   | 1   | 24 V DC       | 24 V DC               | 24 V DC                 |
|   | 2   | N/A           | 0-10 V ANALOG DIMMING | 0-10 V ANALOG DIMMING   |
|   | 3   | DC GND        | DC GND                | DC GND                  |
|   | 4   | N/A           | PNP/ACTIVE LOW GATE   | PNP/ACTIVE HIGH TRIGGER |

The functions listed above are only applicable when this product is configured with built-in 24V, IC, I3, or I3S control, **with** an A-coded 4-position Male M8 connector.

For details on operating configurations without built-in control (C1, C5, Q1, and Q4 control, when available), please refer to Advanced illumination's controller manuals.

## Control Specs

| C1 Connector  | C5 Connector   | ICS 2 (I2)   | ICS 3 (I3)   | ICS 3S (I3S)   | 24   |
|---|--|--|--|--|--|
| <i>For use with:</i><br><b>DCS Series<br/>Controllers</b> | <i>For use with:</i><br><b>Pulsar 320 Strobe<br/>Controller.</b> | Continous in-line<br>controller<br><br><i>Powered with:</i><br><b>24V power supply</b> | Combination<br>strobe/continous<br>in-line controller<br><br><i>Powered with:</i><br><b>24V power supply</b> | Default-OFF<br>strobe/continous<br>in-line controller<br><br><i>Powered with:</i><br><b>24V power supply</b> | Flying/tinned leads<br><br><i>Powered with:</i><br><b>24V power supply</b> |

## Change Notice

PCN No: 135

Date Issued: September 23, 2016

Notice Type: Product Revision Change

Product Type: RL127

### Change Notification Summary

In an effort to improve our products, Advanced illumination (Ai) will update the LEDs used in the RL127 design. This change will result in a brighter, more uniform light. Customers may still buy the current revision of this model until December 16th of 2016. After that time, orders for these products will be converted to their respective RL127 Revision A models.

This LED change will result in additional wavelengths being available: 365nm, 375nm, 385nm, 395nm, 405nm, 455nm, 505nm, 530nm, 590nm, 660nm, 730nm, 850nm and 940nm. Additionally the white LED color temperture will be changing from 6100K to 5000K.

Visable wavelengths will be priced at \$790. This will result in price increase on 470, 625 and White colors. All IR wavelengths will be priced at \$985 list and UV wavelengths at \$1350.

Orders for customized (dash numbers) versions of RL127 will be honored until March 16th of 2017. Ai will be actively working with customers for those products to simplify the transition.

Please contact your Ai Sales Representative if you have any questions.

PCN 135 RL127

### Intensity Distribution

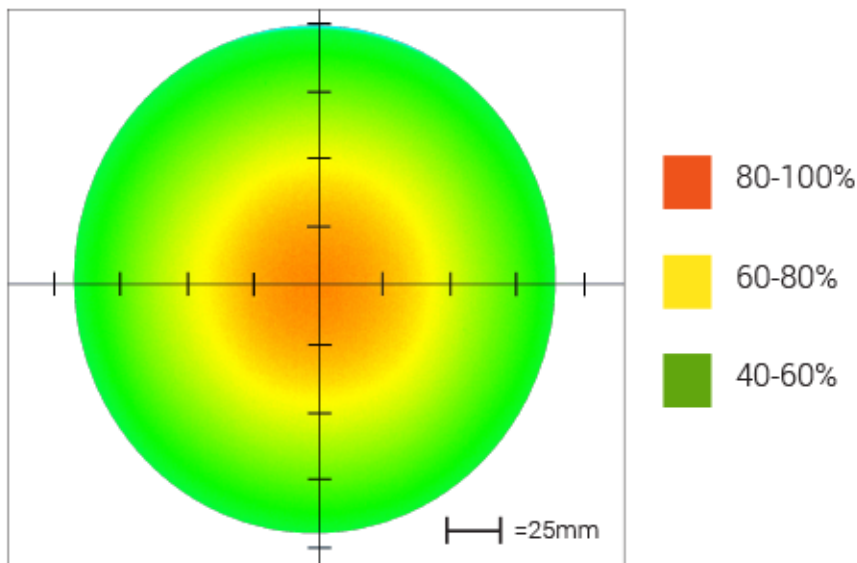

Optical measurement taken using RL127-WHIIC @ 200 mm

### Area of Illuminance & Intensity

Working Area (FWHM)  
@ Working Distance

144 Dia (mm)  
@100 (mm)

226 Dia (mm)  
@200 (mm)

300 Dia (mm)  
@300 (mm)

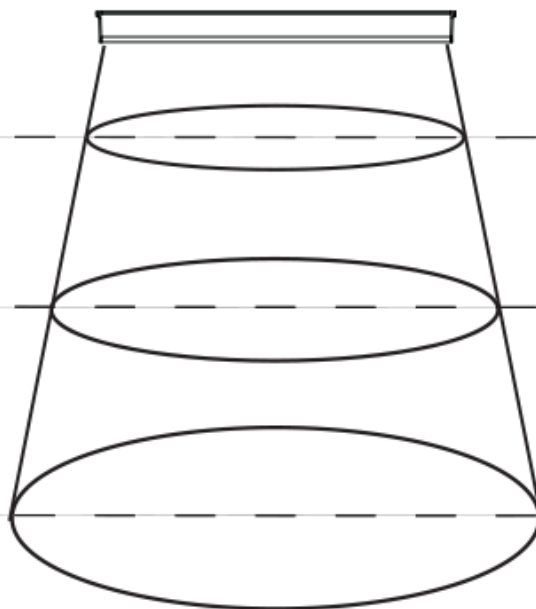

Light Output

Irradiance (W/M<sup>2</sup>): Min 56.9; Typ 67.0  
Illuminance (kLux): Min 17.1; Typ 20.2

Irradiance (W/M<sup>2</sup>): Min 19.5; Typ 23.0  
Illuminance (kLux): Min 5.9; Typ 7.0

Irradiance (W/M<sup>2</sup>): Min 9.3; Typ 11.0  
Illuminance (kLux): Min 2.9; Typ 3.5

## Mechanical Specs

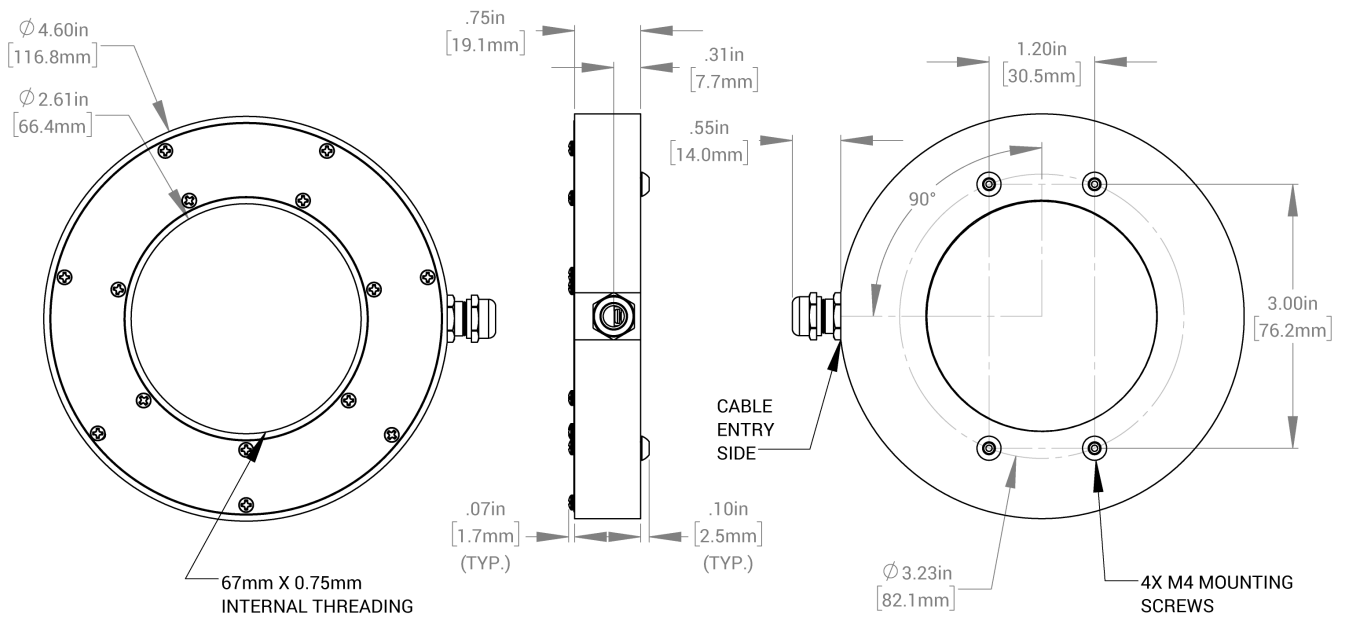

## Warranty Information

Every Advanced illumination, Inc. (Ai) product is thoroughly inspected and tested before leaving the factory. Products are warranted to be free of defects in workmanship and materials for a period of FIVE YEARS from the original date of purchase. Should a defect develop during this period, customers may return the complete product, freight prepaid, to one of Ai's distributors or to the Ai factory. All product warranty returns require a Return Merchandise Authorization (RMA) number which is obtained from Customer Service. The RMA number must be clearly marked on the outside of the package. Ai will inspect the unit, and if a defect is found will, at our option, repair or replace the product without charge. Ai disclaims liability for any implied warranties, including implied warranties of "merchantability" and "fitness for a specific purpose." For products under warranty that have since been discontinued, Ai will make an effort to replace with equivalent parts; for circumstances that do not allow for equivalent replacement, Ai reserves the right to repair or replace these products with an updated version. Ai cannot be held responsible for the unauthorized or inappropriate use of its products. Any unauthorized repair or modifications will result in a voided warranty.

No Liability for Consequential Damages: In no event shall Ai be liable for any consequential, special, incidental, or indirect damages of any kind arising from the sale or use of the products.

## Electromagnetic Compatibility

This product was tested and complies with the regulatory requirements and limits for electromagnetic compatibility (EMC) as stated in the product specifications. These requirements and limits are designed to provide reasonable protection against harmful interference only when the product is operated in its intended industrial electromagnetic environment. To minimize the potential for electromagnetic interference or unacceptable performance degradation, install and use this product in strict accordance with the instructions in the product documentation.

## Customer Service

For information on existing orders, or to make an order adjustment, contact us Monday through Friday 8:00 am to 5:00 pm ET or send an email to [orders@advancedillumination.com](mailto:orders@advancedillumination.com).

## Company Information

### **Advanced Illumination**

440 State Garage Road, Rochester, VT 05767

Phone: 802.767.3830

Fax: 802.767.2636

Email: [info@advancedillumination.com](mailto:info@advancedillumination.com)

Web: [advancedillumination.com](http://advancedillumination.com)

© 2021 Advanced illumination Inc. All rights reserved