

17.52 Optical flange distance

[0.69]

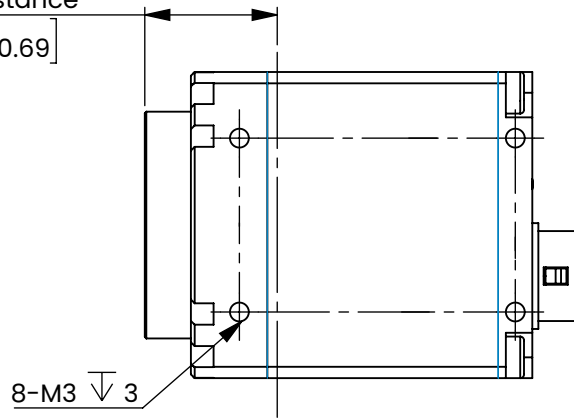

8-M3  $\nabla$  3

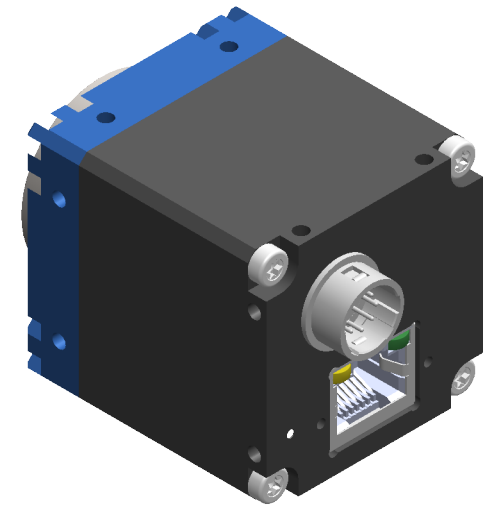

Ethernet interface  
M2 screw holes  
for network cable  
securing

Circular connector  
power and I/O interface

Status indicator  
LED

2-M2  $\nabla$  4

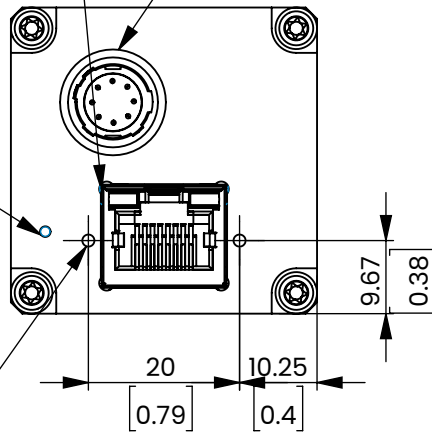

6.41  
[0.25]

36.5  
[1.44]

8-M3  $\nabla$  3  
8.75  
[0.34]

23  
[0.91]

6.1  
[0.24]

20  
[0.79]

10.25  
[0.4]

45.16  
[1.78]

57.56  
[2.27]

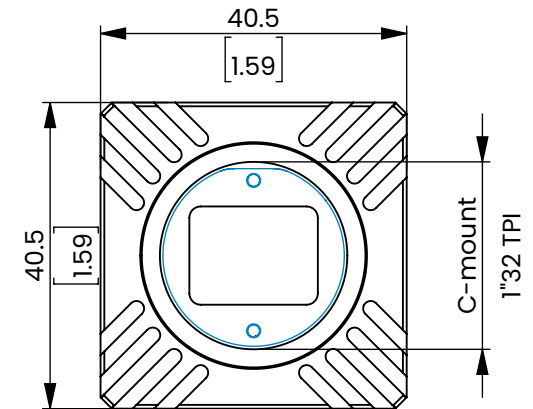

C-mount  
1"32 TPI



This drawing is provided for reference only. It is not approved for manufacturing and the actual component can vary. We encourage that any discrepancies are reported to our CAD department at [CAD@MachineVisionDirect.com](mailto:CAD@MachineVisionDirect.com)

This item is sold and supported worldwide by Machine Vision Direct		NAME	DATE
For Quotes and Support: <a href="mailto:Support@MachineVisionDirect.com">Support@MachineVisionDirect.com</a>		S. Shaikh	07/20/2023
SIZE	PART NUMBER	CHECKED	REV
A	ITA246-GM-20C-EL		A

MANUFACTURER: OPTO ENGINEERING	
SCALE: 1:1	ALL DIMENSIONS ARE IN MILLIMETERS