

17.52 Optical flange

distance
[0.69]

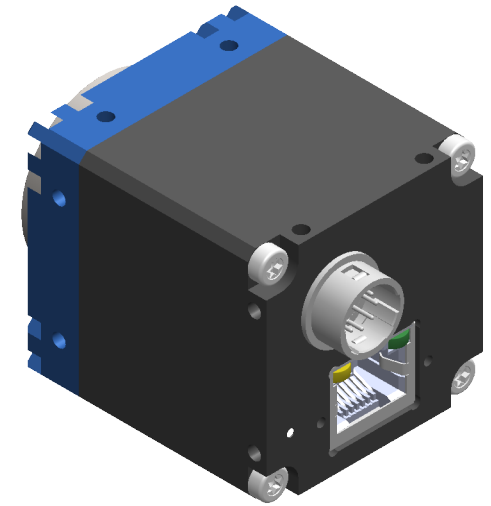
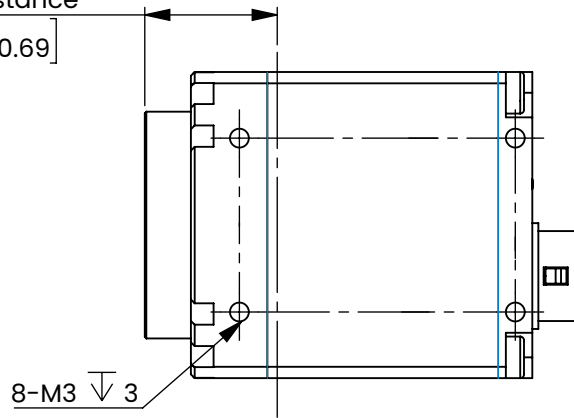

Ethernet interface
M2 screw holes
for network cable
securing

Circular connector
power and I/O interface

Status indicator
LED

2-M2 ∇ 4

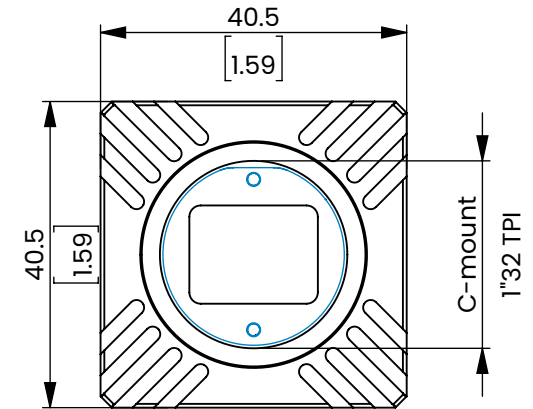
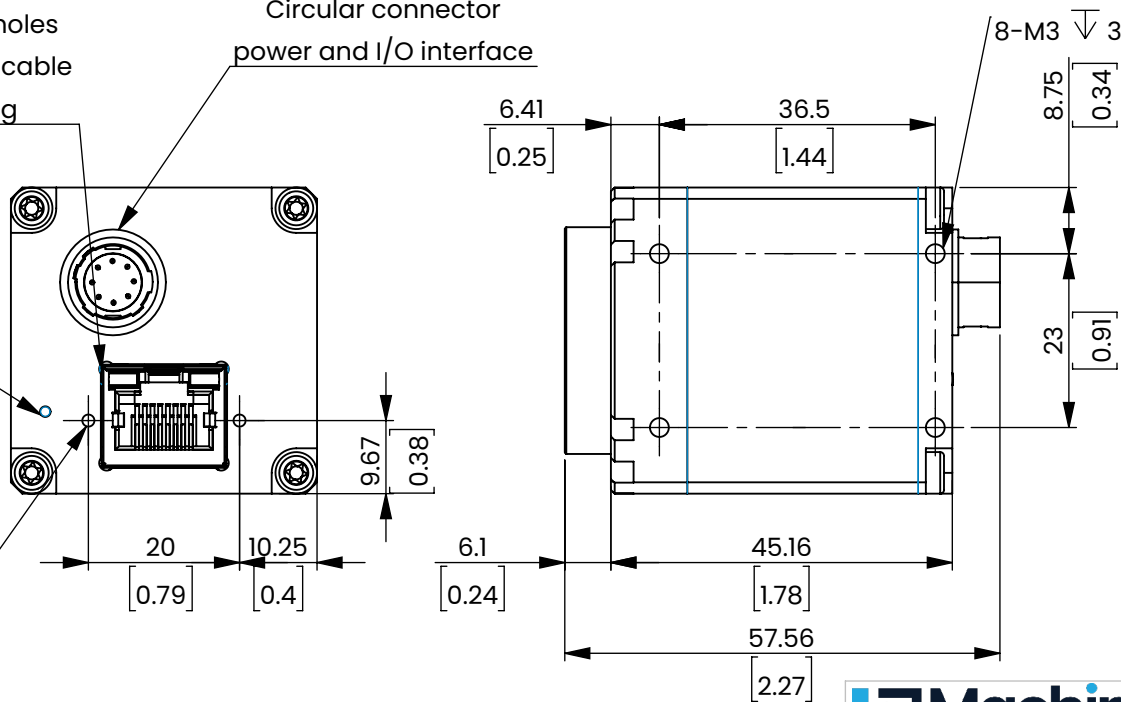

This drawing is provided for reference only. It is not approved for manufacturing and the actual component can vary. We encourage that any discrepancies are reported to our CAD department at CAD@MachineVisionDirect.com

This item is sold and supported worldwide by Machine Vision Direct		NAME	DATE
For Quotes and Support: Support@MachineVisionDirect.com		S. Shaikh	07/20/2023
SIZE	PART NUMBER	CHECKED	REV
A	ITA32-GM-10C		A
MANUFACTURER: OPTO ENGINEERING			
SCALE: 1:1		ALL DIMENSIONS ARE IN MILLIMETERS	