



smart vision lights

4WMD Four-Wavelength DRIVER

EXTERNAL DRIVER

PRODUCT DATA SHEET



PRODUCT HIGHLIGHTS

- ✓ Drive lights with multiple wavelengths, including standard colors, UV, IR, and SWIR
- ✓ Up to four individual channels that can be controlled independently of one another
- ✓ 5-pin M12 quick connect (reserve key)
- ✓ Built-in Multi™ allows light to work in continuous operation or OverDrive™ strobe mode
- ✓ Separate control for each channel to tune intensity for either continuous operation or OverDrive™ strobe mode



PRODUCT DESCRIPTION

The 4WMD is a four-channel external driver developed for multi-wavelength lights. The 4WMD permits up to four individual wavelengths to be controlled independently of each other. This external driver includes Multi-Drive™, which allows a single channel to drive LEDs in continuous operation or OverDrive™ strobe mode separate from the other channels. For quick and easy adjustments, each output channel has its own tuning control located on the front of the driver. Wavelength tuning can be controlled for continuous operation using the analog input channels as well. The 4WMD can be used with any combination of up to four LED wavelengths, including white, red, blue, green, UV, IR, and SWIR. Additional wavelength options are available.



PRODUCT SPECIFICATIONS

PER CHANNEL	Standard	High-Current
Electrical Input	24 V DC +/- 5%	
Electrical Input Connector	2-position screw terminal blocks – 14 AWG max wire size	
Operating Current (No Load)	70 mA	110 mA
Number of Input Channels	4	
Input Connector	10-position screw terminal block – 14 AWG max wire size (4 for channel control, 4 for analog, and 2 for PNP/NPN strobing/trigger)	
On/Off Trigger Input	PNP trigger: +4 V DC or greater to activate (max 26 V DC) NPN trigger: GND (<1 V DC) to activate	
Input Channel Current	PNP input: 4 mA @ 4 V DC 10 mA @ 12 V DC 20 mA @ 24 V DC NPN input: 15 mA @ Ground (0 V DC)	
Analog Intensity	Continuous Operation: The output is adjustable from 10%–100% of intensity by applying 1–10 V DC signal OverDrive™ Strobe Mode: Apply 0 V DC	
Output Channels	4 channels for LED tuning control	
Output Connectors	One 5-pin M12 reverse-key connector	
Indicator Lights	5-position screw terminal block – 14 AWG max wire size Power on = Green light Individual channels = Yellow light Service = Red light	
Mounting	DIN rail	
Dimensions	H = 102 mm (4.0"), L = 119 mm (4.7"), W = 45 mm (1.8")	H = 102 mm (4.0"), L = 119 mm (4.7"), W = 70 mm (2.8")
Ambient Temperature	-18°C–40°C (0°F–104°F)	
Ambient Humidity	0%–95% noncondensing	
Weight	~233 g	~425 g
Compliances	CE, RoHS	
Terminal Block Plugs (Included with 4WMD)	2-position terminal block plug 5-position terminal block plug 10-position terminal block plug	

OUTPUT PER CHANNEL (MAX)	4ZMD-100	4ZMD-250	4ZMD-750	4ZMD-2000
Maximum LED Continuous Current	100 mA	250 mA	750 mA	2 A
Maximum LED OverDrive™ Current	1 A	2 A	6 A	12 A
TOTAL INPUT PER UNIT (MAX)	4ZMD-100	4ZMD-250	4ZMD-750	4ZMD-2000
Continuous Input Current	440 mA	800 mA	2.1 A	5.4 A
Continuous Input Power	10.5 W	19.2 W	50.4 W	130 W
OverDrive™ Input Current	3.4 A	6.4 A	19 A	47 A
OverDrive™ Input Power	82 W	154 W	460 W	1130 W

RESOURCE CORNER



Additional resources, including CAD files, videos, and application examples, are available on our website.

Smart Vision Lights

2359 Holton Road
Muskegon, MI 49445
P: +1 231.722.1199 | F: +1 231.722.9922
smartvisionlights.com
techsupport@smartvisionlights.com
Hours: Monday–Friday | 8 am–5 pm ET

OUTPUT CONFIGURATION

Using a Reverse-Key 5-pin M12 Connector

When connecting a four-wavelength light to a 4WMD using the 5-pin connector, a reverse-key 5-pin M12 cable is required.

The reverse-key 5-pin M12 connector simplifies connecting lights to the 4WMD, with very little wiring needed.

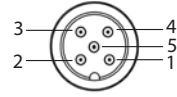

Reverse-Key 5-pin M12 Connector (female)

5-pin M12 Connectors (Female) Pin Layout

Pin	Channel	Color
1	Common	Brown
2	1	White
3	2	Blue
4	3	Black
5	4	Green/Yellow

NOTE:
Smart Vision Lights uses reverse-key cables that have a blue-grey tip on the connectors.

Using Output Terminal Blocks

The terminal block may be used with a custom SVL light or a non-SVL light without a built-in driver. It may also be used when connecting a light without a reverse-key 5-pin M12 connector (with no external driver).

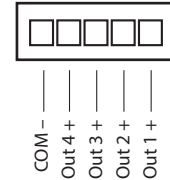

NOTE:
Smart Vision Lights recommends using either the terminal block or the reverse-key 5-pin M12. Using both may result in unexpected results.

WARNING:
When connecting a light to the 4WMD, **do not exceed** the maximum input LED current rating of the light.

WIRING CONFIGURATION

Input Connectors (top of 4WMD)

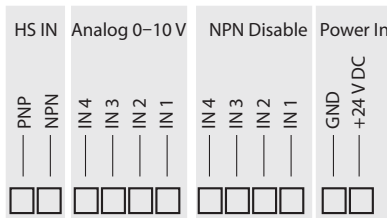

Input Channels

HS IN — High-speed PNP or NPN strobing/trigger

Power In — Power source

NPN Disable — Disable operation of a channel

Analog 0-10 V — Input for setting intensity for continuous mode (1-10 V DC) or OverDrive™ strobe mode (0 V DC)

Output Connectors (bottom of 4WMD)

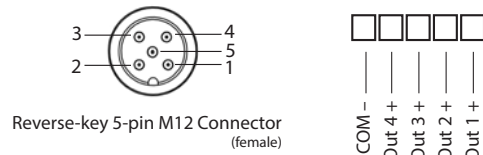

NOTE:
All channels are enabled by default. To disable a channel, connect that channel to ground (GND).
Example: To disable channel 4, connect NPN Disable IN4 to GND.



TUNING WAVELENGTHS

The 4WMD allows for the tuning of up to four individual wavelength intensities. Depending on its configuration, a channel can tune the output intensity of a given wavelength for either continuous operation or OverDrive™ strobe mode. Each channel can be tuned either in continuous operation or OverDrive™ strobe mode, but not both modes simultaneously. Each channel has a yellow indicator light that illuminates when the channel is active.

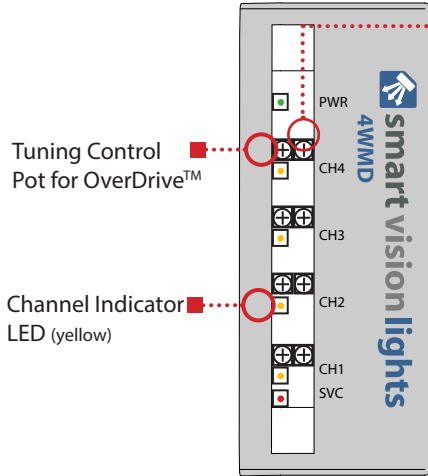

Tuning Control Pot for Continuous

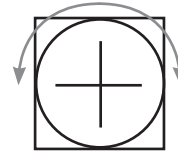

270° turn pot
Clockwise = Increase intensity
Counterclockwise = Decrease intensity

NOTE:

When in continuous mode, channels can be tuned individually using 1–10 V DC on the analog input.



PART NUMBER

4WMD —

CURRENT:

- 100 = 100 mA
- 250 = 250 mA
- 750 = 750 mA
- 2000 = 2 A

Part Number Examples:

4WMD-250 4WMD driver (maximum of 250 mA)

Determine the amount of current needed for the driver:

The current requirement is based on the maximum continuous LED current needed. Smart Vision Lights is able to set the current to a desired value upon request.

Any 4WMD above 750 mA is high current. High-current version is equipped with a cooling fan.

4WMD-2000 is the high current version.



PRODUCT VERSIONS

The 4WMD is available in two versions, depending on the maximum output current. The high-current version is equipped with a cooling fan. **Any 4WMD above 750 mA is high current.**



Standard



High-Current



PRODUCT DRAWING

Dimensions are in mm.

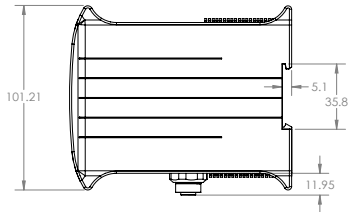

Standard

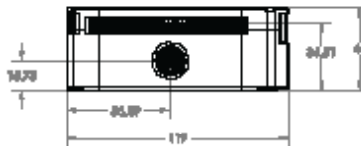

High Current

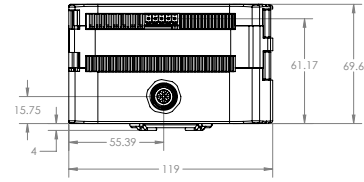

ACCESSORIES

Jumper Cables



Lengths	Part Number
2000 mm	5PM12-J2000-KR



GLOSSARY

This glossary covers all Smart Vision Lights product families; some content in this section may not apply to this specific product.

TERMINOLOGY

OverDrive™ Lights include an integrated high-pulse driver for complete LED light control.

Continuous Operation Light stays on continuously.

Multi-Drive™ Combines continuous operation and OverDrive™ strobe (high-pulse operation) mode into one easy-to-use light.

Built-In Driver The built-in driver allows full function without the need of an external controller.

Camera to Light Connecting the light directly to the camera, without the need for additional controllers or equipment.

Polarizers Filters that reduce reflections on specular surfaces.

Diffuser Used to widen the angle of light emission, reduce reflections, and increase uniformity.

TYPES OF ILLUMINATION

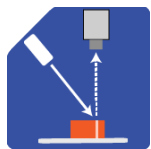

Projector

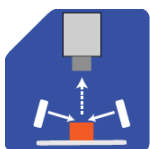

Dark Field

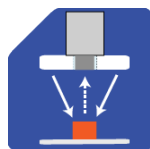

Radial



Bright Field

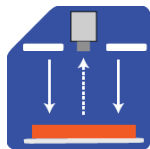

Direct

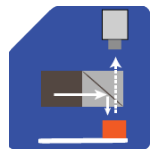

Axial

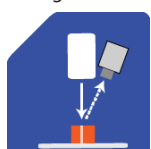

Line



Diffuse Panel

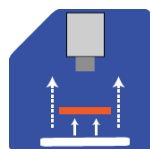

Backlight

COMMON COLOR/WAVELENGTHS LEGEND

Wavelengths options range from 365 nm to 1550 nm.
Additional wavelengths available for many light families.

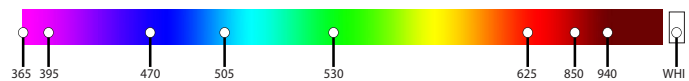

Shortwave infrared LEDs are available in 1050 nm, 1200 nm, 1300 nm, 1450 nm, and 1550 nm.

X = Ground (0V)

X = Positive (24V)

Input Connectors (top of 4WMD)

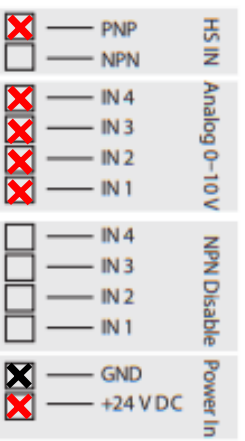

Continuous Mode
All Zones on(PNP)

Input Channels
HS IN — High-speed PNP or NPN strobing/trigger
Power In — Power source
NPN Disable — Disable operation of a channel
Analog 0-10 V — Input for setting intensity for continuous mode (1-10VDC) or OverDrive™ strobe mode (0VDC)

Input Connectors (top of 4WMD)

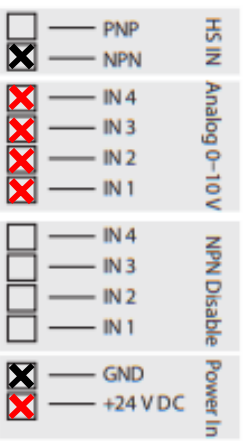

Continuous Mode
All Zones on(NPN)

Input Channels
HS IN — High-speed PNP or NPN strobing/trigger
Power In — Power source
NPN Disable — Disable operation of a channel
Analog 0-10 V — Input for setting intensity for continuous mode (1-10VDC) or OverDrive™ strobe mode (0VDC)

OverDrive Mode
All Zones on(PNP)

Input Connectors (top of 4WMD)

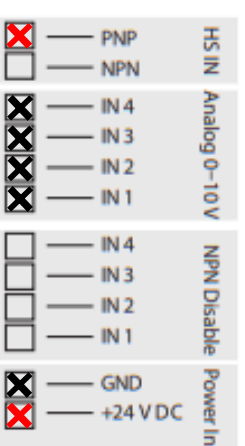

Input Channels
HS IN — High-speed PNP or NPN strobing/trigger
Power In — Power source
NPN Disable — Disable operation of a channel
Analog 0-10 V — Input for setting intensity for continuous mode (1-10VDC) or OverDrive™ strobe mode (0VDC)

Input Connectors (top of 4WMD)

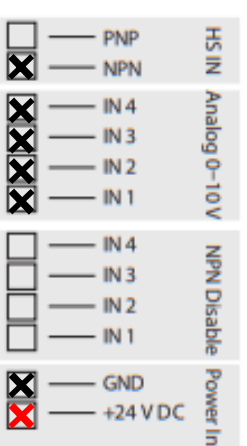

OverDrive Mode
All Zones on(NPN)

Input Channels
HS IN — High-speed PNP or NPN strobing/trigger
Power In — Power source
NPN Disable — Disable operation of a channel
Analog 0-10 V — Input for setting intensity for continuous mode (1-10VDC) or OverDrive™ strobe mode (0VDC)

X = Ground (0V)

X = Positive (24V)

Continuous Mode

One Zone

Disabled(PNP)

HS IN	Analog 0–10 V	NPN Disable	Power In
PNP	I4	I4	GND
NPN	I3	I3	+24 V DC
	I2	I2	
	I1	I1	
	<input checked="" type="checkbox"/>	<input checked="" type="checkbox"/>	<input checked="" type="checkbox"/>
	<input checked="" type="checkbox"/>	<input checked="" type="checkbox"/>	<input checked="" type="checkbox"/>
	<input checked="" type="checkbox"/>	<input checked="" type="checkbox"/>	<input checked="" type="checkbox"/>
	<input checked="" type="checkbox"/>	<input checked="" type="checkbox"/>	<input checked="" type="checkbox"/>
	<input checked="" type="checkbox"/>	<input checked="" type="checkbox"/>	<input checked="" type="checkbox"/>
	<input type="checkbox"/>	<input type="checkbox"/>	<input checked="" type="checkbox"/>
	<input type="checkbox"/>	<input type="checkbox"/>	<input checked="" type="checkbox"/>
	<input type="checkbox"/>	<input type="checkbox"/>	<input checked="" type="checkbox"/>
	<input type="checkbox"/>	<input type="checkbox"/>	<input checked="" type="checkbox"/>

Input Channels

HS IN — High-speed PNP or NPN strobing/trigger
Power In — Power source

NPN Disable — Disable operation of a channel
Analog 0–10 V — Input for setting intensity for continuous mode (1–10VDC) or OverDrive™ strobe mode (0VDC)

Input Connectors

(top of 4WMD)

Continuous Mode

One Zone

Disabled(NPN)

HS IN	Analog 0–10 V	NPN Disable	Power In
PNP	I4	I4	GND
NPN	I3	I3	+24 V DC
	I2	I2	
	I1	I1	
	<input checked="" type="checkbox"/>	<input checked="" type="checkbox"/>	<input checked="" type="checkbox"/>
	<input checked="" type="checkbox"/>	<input checked="" type="checkbox"/>	<input checked="" type="checkbox"/>
	<input checked="" type="checkbox"/>	<input checked="" type="checkbox"/>	<input checked="" type="checkbox"/>
	<input checked="" type="checkbox"/>	<input checked="" type="checkbox"/>	<input checked="" type="checkbox"/>
	<input checked="" type="checkbox"/>	<input checked="" type="checkbox"/>	<input checked="" type="checkbox"/>
	<input type="checkbox"/>	<input type="checkbox"/>	<input checked="" type="checkbox"/>
	<input type="checkbox"/>	<input type="checkbox"/>	<input checked="" type="checkbox"/>
	<input type="checkbox"/>	<input type="checkbox"/>	<input checked="" type="checkbox"/>
	<input type="checkbox"/>	<input type="checkbox"/>	<input checked="" type="checkbox"/>

Input Channels

HS IN — High-speed PNP or NPN strobing/trigger
Power In — Power source

NPN Disable — Disable operation of a channel
Analog 0–10 V — Input for setting intensity for continuous mode (1–10VDC) or OverDrive™ strobe mode (0VDC)

OverDrive Mode

One Zone

Disabled(PNP)

HS IN	Analog 0–10 V	NPN Disable	Power In
PNP	I4	I4	GND
NPN	I3	I3	+24 V DC
	I2	I2	
	I1	I1	
	<input checked="" type="checkbox"/>	<input checked="" type="checkbox"/>	<input checked="" type="checkbox"/>
	<input checked="" type="checkbox"/>	<input checked="" type="checkbox"/>	<input checked="" type="checkbox"/>
	<input checked="" type="checkbox"/>	<input checked="" type="checkbox"/>	<input checked="" type="checkbox"/>
	<input checked="" type="checkbox"/>	<input checked="" type="checkbox"/>	<input checked="" type="checkbox"/>
	<input checked="" type="checkbox"/>	<input checked="" type="checkbox"/>	<input checked="" type="checkbox"/>
	<input type="checkbox"/>	<input type="checkbox"/>	<input checked="" type="checkbox"/>
	<input type="checkbox"/>	<input type="checkbox"/>	<input checked="" type="checkbox"/>
	<input type="checkbox"/>	<input type="checkbox"/>	<input checked="" type="checkbox"/>
	<input type="checkbox"/>	<input type="checkbox"/>	<input checked="" type="checkbox"/>

Input Channels

HS IN — High-speed PNP or NPN strobing/trigger
Power In — Power source

NPN Disable — Disable operation of a channel
Analog 0–10 V — Input for setting intensity for continuous mode (1–10VDC) or OverDrive™ strobe mode (0VDC)

Input Connectors

(top of 4WMD)

OverDrive Mode

One Zone

Disabled(NPN)

HS IN	Analog 0–10 V	NPN Disable	Power In
PNP	I4	I4	GND
NPN	I3	I3	+24 V DC
	I2	I2	
	I1	I1	
	<input checked="" type="checkbox"/>	<input checked="" type="checkbox"/>	<input checked="" type="checkbox"/>
	<input checked="" type="checkbox"/>	<input checked="" type="checkbox"/>	<input checked="" type="checkbox"/>
	<input checked="" type="checkbox"/>	<input checked="" type="checkbox"/>	<input checked="" type="checkbox"/>
	<input checked="" type="checkbox"/>	<input checked="" type="checkbox"/>	<input checked="" type="checkbox"/>
	<input checked="" type="checkbox"/>	<input checked="" type="checkbox"/>	<input checked="" type="checkbox"/>
	<input type="checkbox"/>	<input type="checkbox"/>	<input checked="" type="checkbox"/>
	<input type="checkbox"/>	<input type="checkbox"/>	<input checked="" type="checkbox"/>
	<input type="checkbox"/>	<input type="checkbox"/>	<input checked="" type="checkbox"/>
	<input type="checkbox"/>	<input type="checkbox"/>	<input checked="" type="checkbox"/>

Input Channels

HS IN — High-speed PNP or NPN strobing/trigger
Power In — Power source

NPN Disable — Disable operation of a channel
Analog 0–10 V — Input for setting intensity for continuous mode (1–10VDC) or OverDrive™ strobe mode (0VDC)