



smart vision lights

# 4ZMD

# Four-Zone DRIVER

EXTERNAL DRIVER

## PRODUCT DATA SHEET

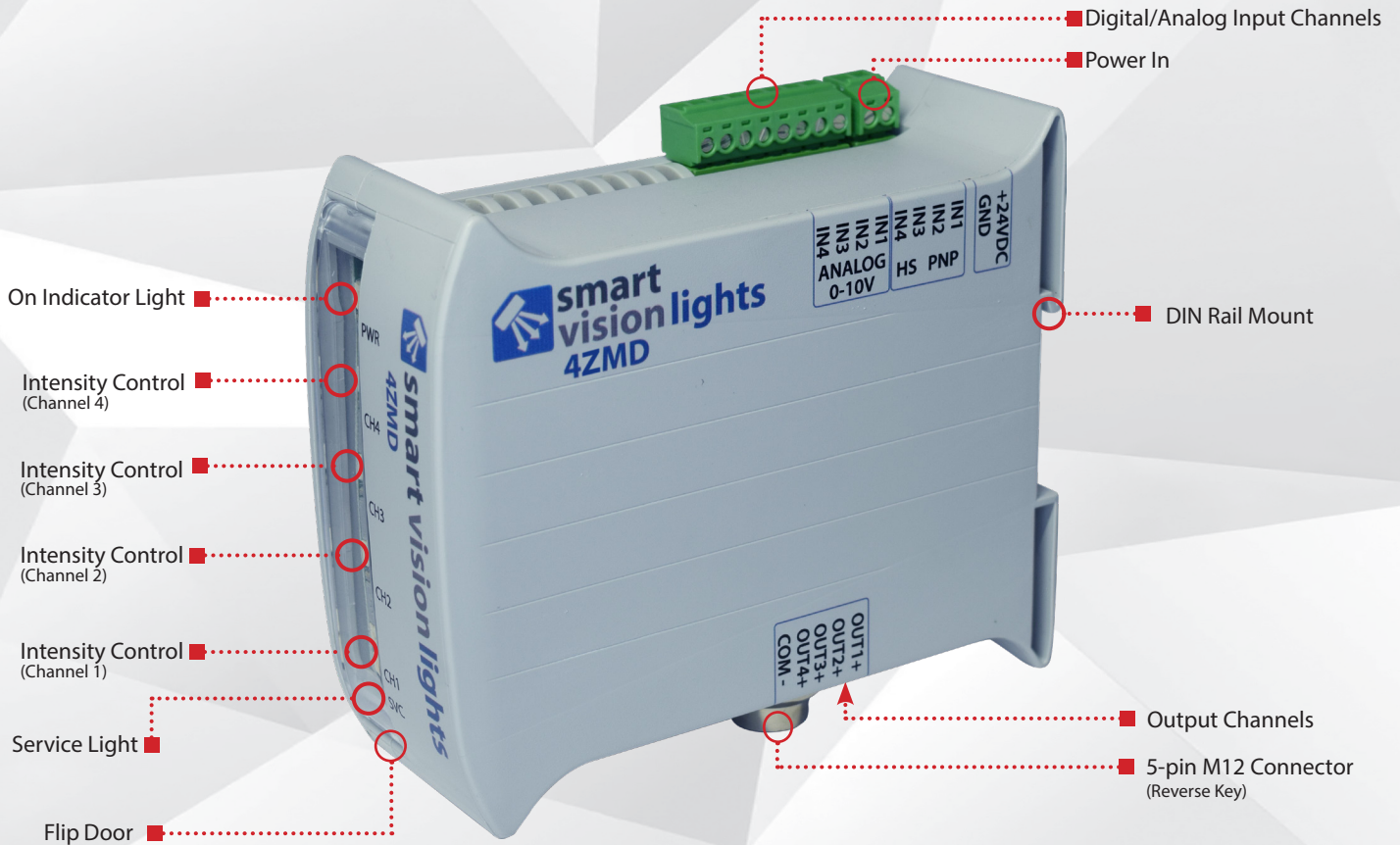

Warranty  
**3**  
YEAR

Mount  
**DIN**  
RAIL

Compliant  
**CE**  
RoHS

Zones  
UPTO  
**4**

Connector  
**5-PIN**  
**M12**  
(Reverse Key)

## PRODUCT HIGHLIGHTS

- ✓ Four individual channels that can be controlled independently of one another
- ✓ Works with LED Light Manager (LLM)
- ✓ 5-pin M12 quick connect (reverse key)
- ✓ Built-in Multi-Drive™ allows light to work in continuous operation or OverDrive™ strobe mode
- ✓ Separate control for each channel to control intensity for either continuous operation or OverDrive™ strobe mode



## PRODUCT DESCRIPTION

The 4ZMD is an external driver with four individual built-in channels, allowing control of up to four zones within a single light or four individual lights with no built-in drivers. Users can set different intensity levels for each zone channel because they act independently of each other. Also, depending on the channel's configuration, intensity controls can adjust the intensity for either continuous operation or OverDrive™ strobe mode.

When connected to the LED Light Manager (LLM), each individual channel can be set to continuous on, off, any intensity level in between, and even OverDrive™ strobe mode.

For more information about the LLM, visit [smartvisionlights.com/products/llm](http://smartvisionlights.com/products/llm).



## PRODUCT SPECIFICATIONS

PER CHANNEL	Standard	High Current		
Electrical Input	24VDC +/- 5%			
Electrical Input Connector	2-position screw terminal block — 14 AWG max wire size			
Operating Current (No Load)	70 mA	110 mA (Includes fan)		
Number of Input Channels	4			
Input Connector	8-position screw terminal block — 14 AWG max wire size (4 for PNP and 4 for analog)			
On/Off Trigger Input	PNP trigger: +4VDC or greater to activate (max 26VDC)			
Input Channel Current	PNP input: 4 mA @ 4VDC   10 mA @ 12VDC   20 mA @ 24VDC			
Analog Intensity Input	Continuous Operation: The output is adjustable from 10%–100% of intensity by applying 1–10VDC signal OverDrive™ Strobe Mode: Apply 0VDC			
Output Channels	4 channels for LED control			
Output Connectors	One 5-pin M12 reverse-key connector 5 position screw terminal block – 14 AWG max wire size			
Indicator Lights	Power on = Green light Individual channels = Yellow light Service = Red light			
Mounting	DIN rail			
Dimensions	H = 102 mm (4.0"), L = 119 mm (4.7"), W = 45 mm (1.8")	H = 102 mm (4.0"), L = 119 mm (4.7"), W = 70 mm (2.8")		
Ambient Temperature	-18°C–40°C (0°F–104°F)			
Ambient Humidity	0%–95% noncondensing			
Weight	~233 g	~425 g		
Compliances	CE, RoHS			
Terminal Block Plugs (Included with 4ZMD)	2-position terminal block plug 5-position terminal block plug 8-position terminal block plug			
<b>OUTPUT PER CHANNEL (MAX)</b>	<b>4ZMD-100</b>	<b>4ZMD-250</b>	<b>4ZMD-750</b>	<b>4ZMD-2000</b>
Maximum LED Continuous Current	100 mA	250 mA	750 mA	2 A
Maximum LED OverDrive™ Current	1 A	2 A	6 A	12 A
<b>TOTAL INPUT PER UNIT (MAX)</b>	<b>4ZMD-100</b>	<b>4ZMD-250</b>	<b>4ZMD-750</b>	<b>4ZMD-2000</b>
Continuous Input Current	440 mA	800 mA	2.1 A	5.4 A
Continuous Input Power	10.5 W	19.2 W	50.4 W	130 W
OverDrive™ Input Current	3.4 A	6.4 A	19 A	47 A
OverDrive™ Input Power	82 W	154 W	460 W	1130 W



## RESOURCE CORNER

Additional resources, including CAD files, videos, and application examples, are available on our website.



## PRODUCT DRAWING

Dimensions are in mm.

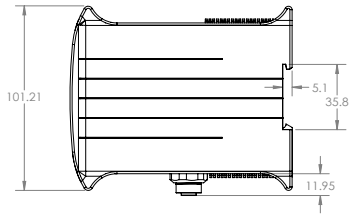

### Standard

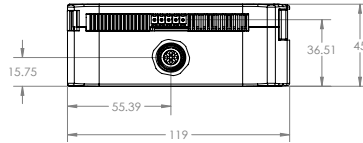

### High Current

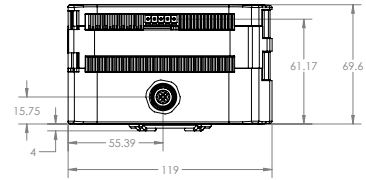

## OUTPUT CONFIGURATION

### Using the Reverse-Key 5-pin M12 Connector

When connecting a Smart Vision Lights four-zone light to a 4ZMD using the 5-pin connector, a reverse-key 5-pin M12 cable is required. All Smart Vision Lights four-zone lights come equipped with a 5-pin reverse-key connector.

The reverse key 5-pin M12 connector simplifies connecting lights to the 4ZMD, with very little wiring needed.

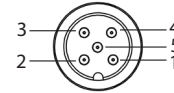

Reverse-Key 5-pin M12 Connector (female)

### 5-pin M12 Connectors (Female) Pin Layout

Pin	Channel	Color
1	Common	Brown
2	1	White
3	2	Blue
4	3	Black
5	4	Green/Yellow

#### NOTE:

Smart Vision Lights uses reverse key cables that have a blue-grey tip on the connectors.

### Using Output Terminal Blocks

The terminal block may be used with a custom SVL light or a non-SVL light without a built in-driver. It may also be used when connecting a light without a reverse-key 5-pin M12 connector (with no external driver).

#### NOTE:

Smart Vision Lights recommends using either the terminal block or the reverse key 5-pin M12. Using both may cause unexpected results.

#### WARNING:

When connecting a light to the 4ZMD, **do not exceed** the maximum input LED current rating of the light.

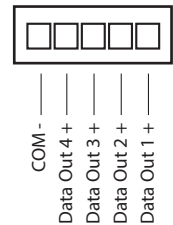

## WIRING CONFIGURATION

### Input Connectors

(top of 4ZMD)

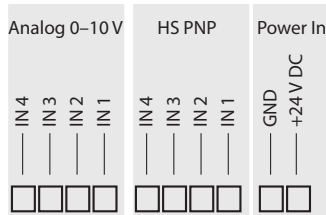

### Input Channels for 4ZMD

**Power In** — Power source

**HS PNP** — High-speed PNP strobing/trigger

**Analog 0—10 V** — Input for setting intensity for continuous mode (1—10VDC) or OverDrive™ strobe mode (0VDC)

### Output Connectors

(bottom of 4ZMD)

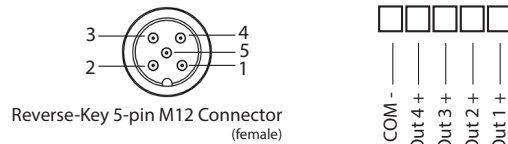

## INPUT CONFIGURATION

### Using Input Terminal Block

Input terminal block is also used when connecting to the LED Light Manager (LLM).

Smart Vision Lights recommends using the interconnect cable (part number: IC-400) to connect the 4ZMD driver to the LLM.

LLM Output Channels	4ZMD Input Channels
DO1	PNP IN1
DO2	PNP IN2
DO3	PNP IN3
DO4	PNP IN4
DO5/AO1	Analog 1
DO6/AO2	Analog 2
DO7/AO3	Analog 3
DO8/AO4	Analog 4

## MANAGING ZONES

Connect the LED Light Manager (LLM) to the 4ZMD driver. The LLM allows for easy control of each individual zone. The event programmed within the LLM can contain multiple sequences, each with the ability to set its zone to continuous on, off, any intensity level in between, and even OverDrive™ strobe mode.

For more information about how to use the LED Light Manager (LLM), see the LED Light Manager data sheet.

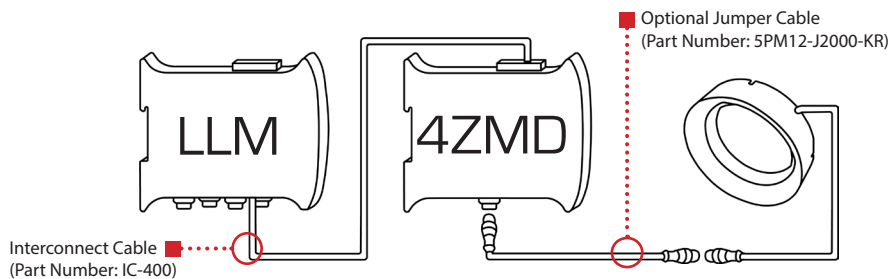

## UNDERSTANDING ZONES

Smart Vision Lights offers lights with four individual built-in zones, allowing each zone to act independently of one another. Each zone can be set to continuous on, off, or any intensity level in between, and even OverDrive™ strobe mode. Intensity levels can be set by programming the LLM to control the zones or by using the intensity controls on the front of the 4ZMD (see Managing Zones and Adjusting Intensity).

These four-zone lights enable any combination of the zones to be turned on at the same time, including adjacent and opposing zones.





## ADJUSTING INTENSITY

The 4ZMD allows for the control of up to four individual channel intensity levels. Depending on how the channel is wired, its intensity can be adjusted for either continuous operation or OverDrive™ strobe mode. Each channel intensity can be adjusted either in continuous operation or OverDrive™ strobe mode, but not both modes simultaneously. Each channel has a yellow indicator light that will illuminate when the channel is active.

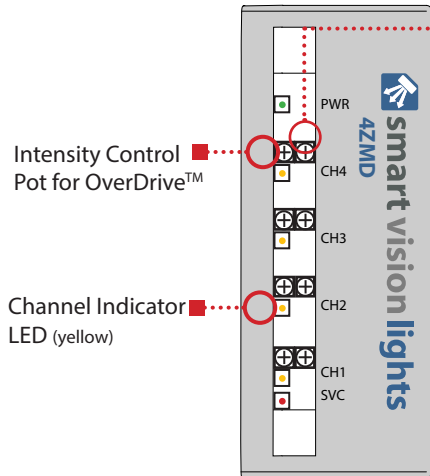

Intensity Control Pot for Continuous

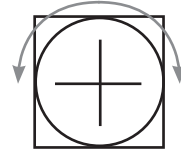

**270° turn pot**  
**Clockwise = Increase intensity**  
**Counterclockwise = Decrease intensity**

**NOTE:**

When in continuous mode, channel intensity can be adjusted using 1—10 V DC on the analog input.

**NOTE:**

When managing the 4ZMD with the LLM, turn the intensity pots on the front of the 4ZMD fully clockwise to ensure intensity is completely controlled by the LLM.



## PART NUMBER

**4ZMD** —

**CURRENT:**

- 100** = 100 mA
- 250** = 250 mA
- 750** = 750 mA
- 2000** = 2 A

**Part Number Examples:**

**4ZMD-250** 4ZMD driver (maximum of 250 mA)

**Determine the amount of current needed for the driver:**

The current requirement is based on the maximum continuous LED current needed. Smart Vision Lights is able to set the current to a desired value upon request.

**Any 4ZMD above 750 mA is high-current. High-current version is equipped with a cooling fan.**

4ZMD-2000 is the high-current version.



## PRODUCT VERSIONS

The 4ZMD is available in two versions, depending on the maximum continuous LED current. The high-current version is equipped with a cooling fan. **Any 4ZMD above 750 mA is high-current.**



Standard



High-Current



## ACCESSORIES

Jumper Cables	
	
Lengths	Part Number
2000 mm	5PM12-J2000-KR

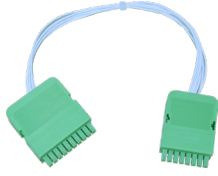
Interconnect Cable	
	
Lengths	Part Number
400 mm	IC-400



## GLOSSARY

This glossary covers all Smart Vision Lights product families; some content in this section may not apply to this specific product.

### TERMINOLOGY

**OverDrive™** Lights include an integrated high-pulse driver for complete LED light control.

**Continuous Operation** Light stays on continuously.

**Multi-Drive™** Combines continuous operation and OverDrive™ strobe (high-pulse operation) mode into one easy-to-use light.

**Built-In Driver** The built-in driver allows full function without the need of an external controller.

**Camera to Light** Connecting the light directly to the camera, without the need for additional controllers or equipment.

**Polarizers** Filters that reduce reflections on specular surfaces.

**Diffuser** Used to widen the angle of light emission, reduce reflections, and increase uniformity.

### TYPES OF ILLUMINATION

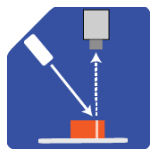

Projector

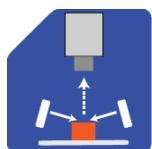

Dark Field

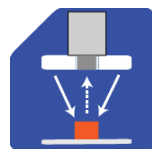

Radial



Bright Field

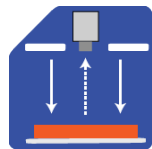

Direct

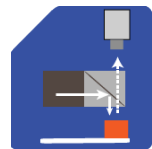

Axial

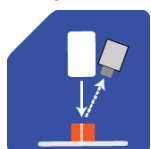

Line

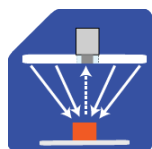

Diffuse Panel

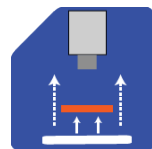

Backlight

### COMMON COLOR/WAVELENGTHS LEGEND

Wavelengths options range from 365 nm to 1550 nm.  
Additional wavelengths available for many light families.

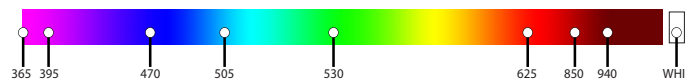

Shortwave infrared LEDs are available in 1050 nm, 1200 nm, 1300 nm, 1450 nm, and 1550 nm.