

# JWL225-MD

## CTL Series DIRECT TO CAMERA

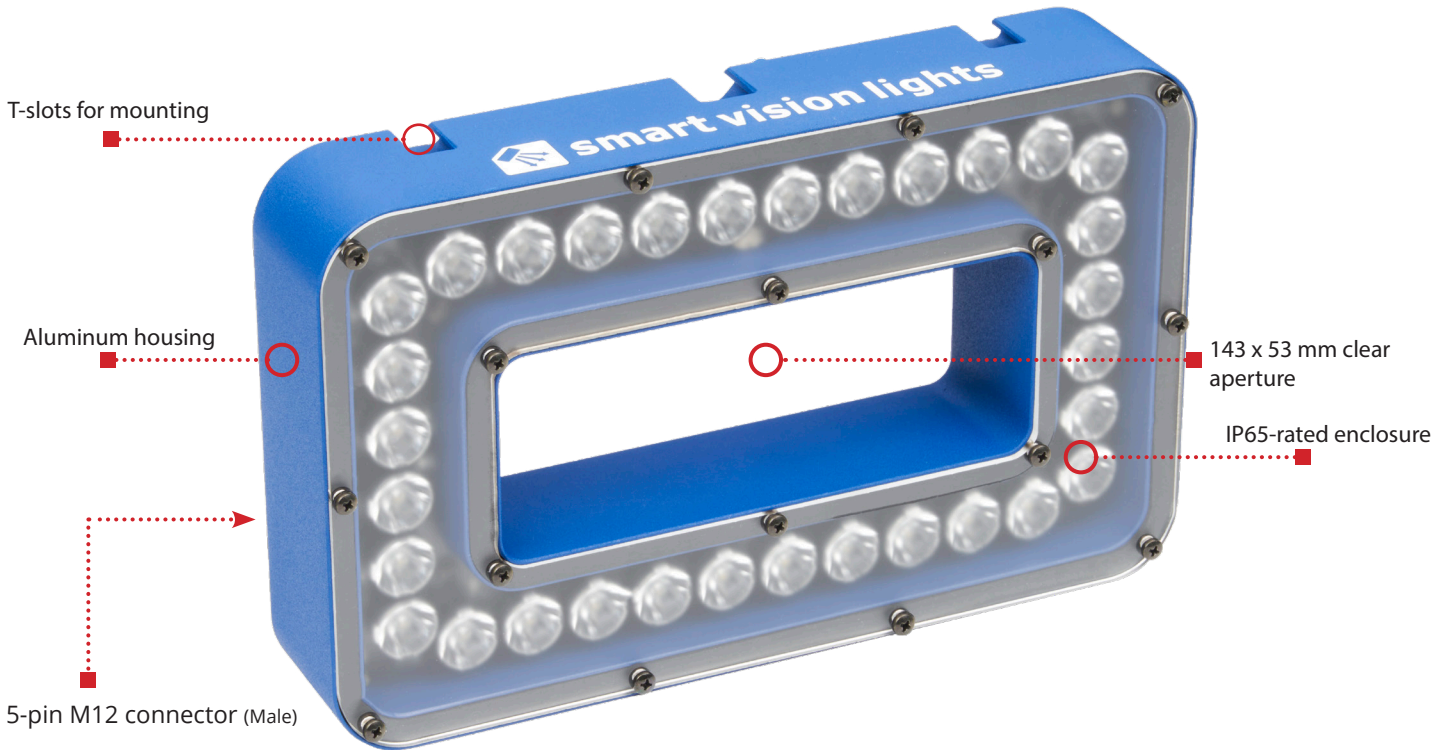

The JWL225-MD, part of the Camera to Light (CTL) Series, is an intense light source meant to provide external illumination for machine vision cameras or smart cameras where the built-in illumination is not enough. This light can be connected directly to camera housings through optional mounting plates to illuminate areas larger than what is normally covered by the camera's internal light source. The JWL225-MD is compatible with many machine vision cameras and can be directly connected and controlled through a camera's trigger output.

### JWL225-MD HIGHLIGHTS

Warranty  
**10  
YEAR**

Tested  
**IEC  
62471**

Compliant  
**CE  
ROHS**

Rated  
**IP  
65**

Connector  
**5-PIN  
M12**

- ✓ Multi-Drive™ provides the ability for either continuous or OverDrive™ strobe modes
- ✓ Compatible with many machine vision cameras
- ✓ Direct connect and control through camera's trigger output
- ✓ Mount camera directly to the light



## SPECIFICATIONS

	Continuous Operation	OverDrive™ Operation
Electrical Input	24 VDC +/- 5%	
Input Current	Max. 1.4 A	Peak 13 A during strobe
Input Power	34 W	Peak 312 W during strobe
PNP Trigger	2 mA @ 4 VDC   7 mA @ 12 VDC   13.4 @ 24 VDC	
NPN Trigger	9.9 mA @ Common (0VDC)	
Trigger Input	PNP > +3.3 VDC (24 VDC max.) to activate <b>or</b> NPN > GND (<1.4 VDC) to activate ( <b>not both</b> )	PNP > +3.3 VDC (24 VDC max.) to activate <b>or</b> NPN > GND (<1.4 VDC) to activate ( <b>not both</b> )
Mode Control	Connect pin 5 to 1-10 VDC (10 - 100% output); 24 VDC (Max)	Connect pin 5 to GND (See wiring configuration for more information)
Strobe Duration	Min. 30 μs   Max. ∞	Min. 10 μs   Max. 50 ms
Strobe Trigger Latency	30 μs	6 μs
Strobe Frequency	Max 4 kHz or 1 / Duty Cycle as calculated, whichever is less. <sup>1</sup>	
Duty Cycle	Not applicable	Max. 10% <sup>1</sup>
Analog Intensity	The output is adjustable from 10% - 100% of intensity limit by a 1 - 10 VDC signal. Jumpering pin 5 to pin 1 will provide maximum intensity. Intensity limit can be remotely adjusted via SmartVisionLink™ <sup>2</sup>	
Connection	5-pin M12 connector	
Operating Temperature	-10° - 40° C (14° - 104° F)   RH max 80% non-condensing humidity	
Storage Temperature	-20° to 70° C (-4° to 158° F)   RH max 80% non-condensing humidity	
IP Rating	IP65	
Weight	3.3 lbs   1.5 kg	
Compliances (Pending)	CE, IEC-62471, RoHS, UL, CSA, FCC, KCC Pending	
Warranty	10 years <sup>3</sup>	

<sup>1</sup>See page 5 for more information

<sup>2</sup>SmartVisionLink™ requires the purchase of the BTM-1000 bluetooth module, sold separately, and the SmartVisionLink™ app, free to download on the Apple App and Google Play stores.

<sup>3</sup>See SmartVisionLights.com/warranty for details.

## WIRING CONFIGURATION

### CONTINUOUS OPERATION MODE

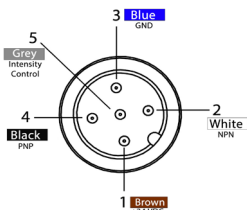

Pin layout for light (Male Connector)

Pins	Function	Signal	Wire Color
1	Power In	+24VDC	BROWN
2	NPN	Sinking Signal	WHITE
3	GND	Ground	BLUE
4	PNP	Sourcing Signal	BLACK
5	Intensity Control	1-10VDC	GREY

For maximum intensity, tie pin 5 to pin 1 at +24VDC.

For continuous mode: PNP (pin 4) can be tied to +24 V DC (pin 1) **or** NPN (pin 2) can be tied to Ground (pin 3).

**For proper light function, apply either a PNP or NPN signal, not both.**

**Failure to supply light with correct input current will result in inconsistent lighting behavior.**

(see Product Specifications for requirements)

## WIRING CONFIGURATION (continued)

### OVERDRIVE OPERATION MODE

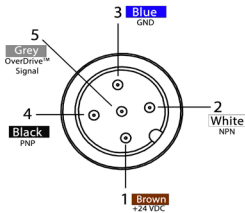

Pin layout for light (Male Connector)

Pins	Function	Signal	Wire Color
1	Power In	+24VDC	BROWN
2	NPN	Sinking Signal	WHITE
3	GND	Ground	BLUE
4	PNP	Sourcing Signal	BLACK
5	OverDrive™ Signal	Ground	GREY

To enable OverDrive™ mode, tie pin 5 to pin 3.

For proper light function, apply either a PNP or NPN signal, not both.

Failure to supply light with correct input current will result in inconsistent lighting behavior.

(see Product Specifications for requirements)

## LIGHTING PATTERNS

Smart Vision Lights recommends the JWL225-MD be used at a working distance between 300 mm to 1500 mm. Illuminance values taken on white light - 5700K

### 10° lighting patterns

Illuminance vs. Working Distance

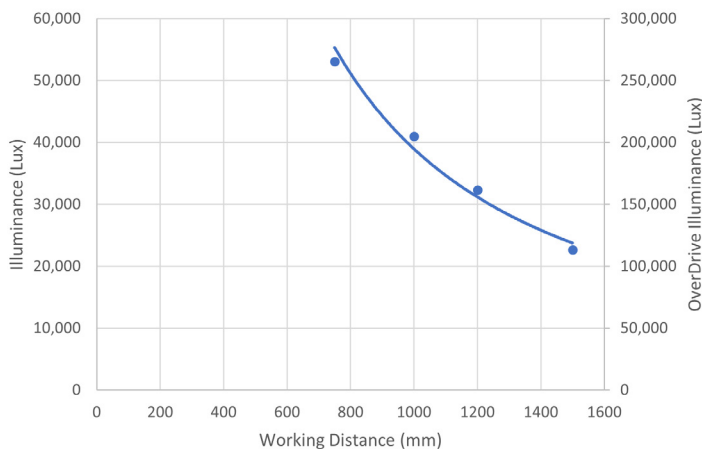

Beam Size at 80% Max Intensity vs. Working Distance

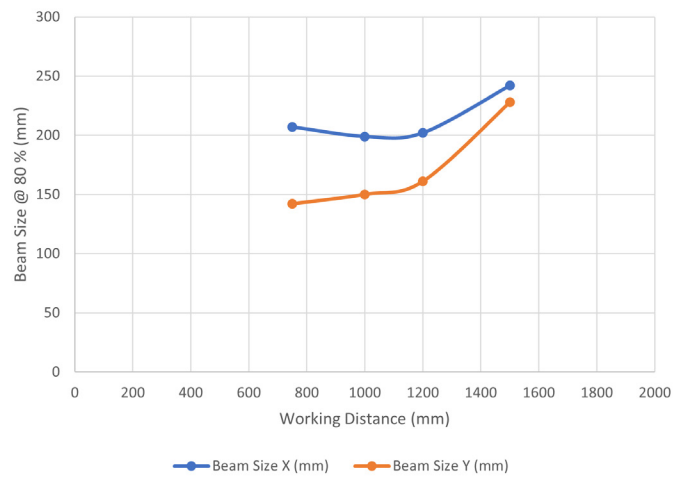

### 14° lighting patterns

Illuminance vs. Working Distance

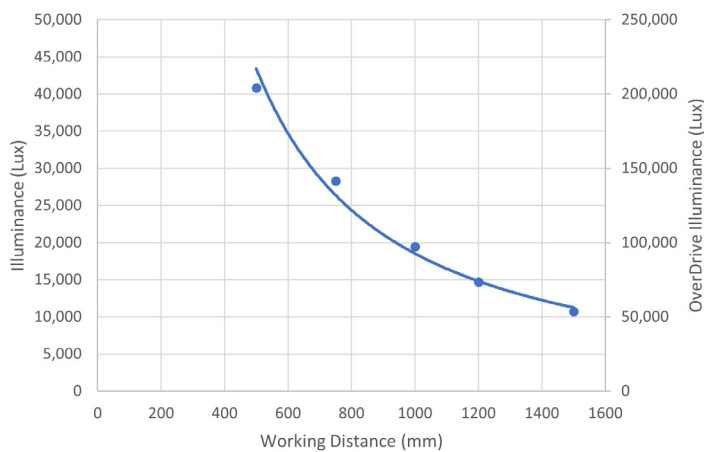

Beam Size at 80% Max Intensity vs. Working Distance

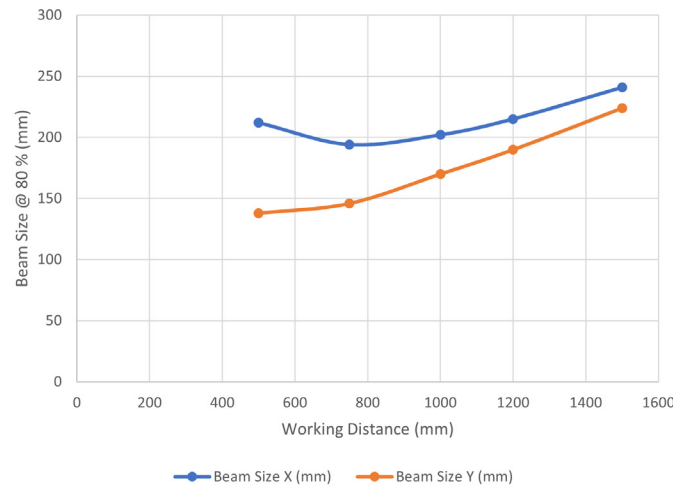

## LIGHTING PATTERNS (continued)

Smart Vision Lights recommends the JWL225-MD be used at a working distance between 300 mm to 1500 mm. Illuminance values taken on white light - 5700K

### 30° lighting patterns

Illuminance vs. Working Distance

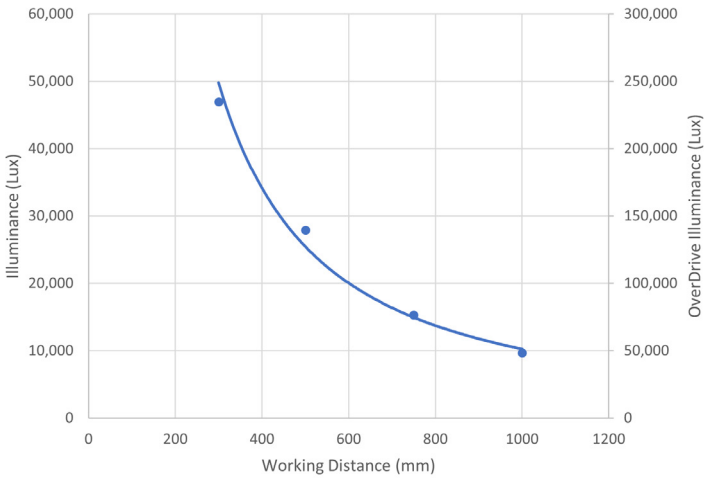

Beam Size at 80% Max Intensity vs. Working Distance

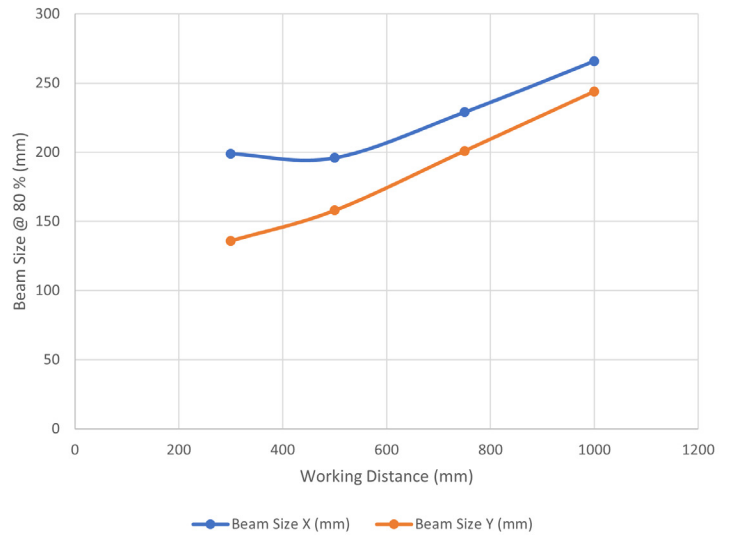

## BEAM PATTERNS

### 10° lighting patterns

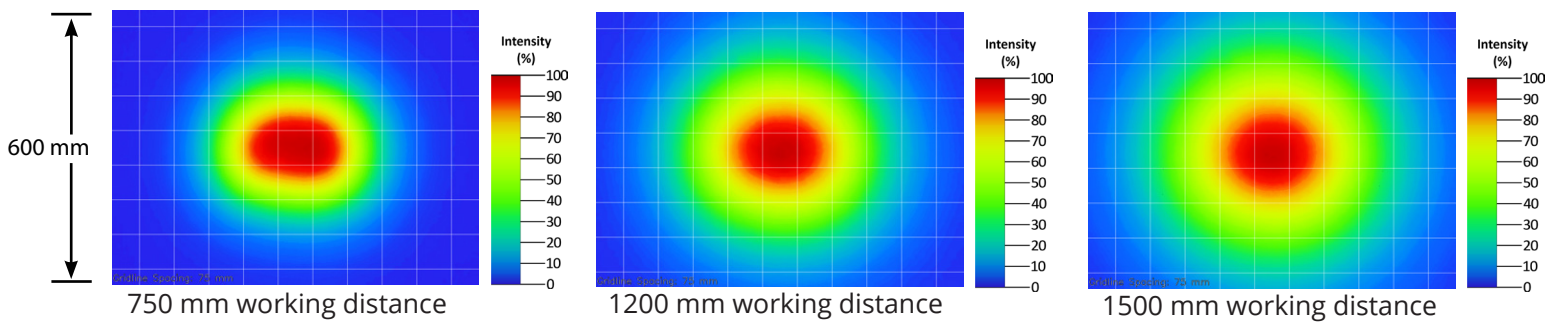

### 14° lighting patterns

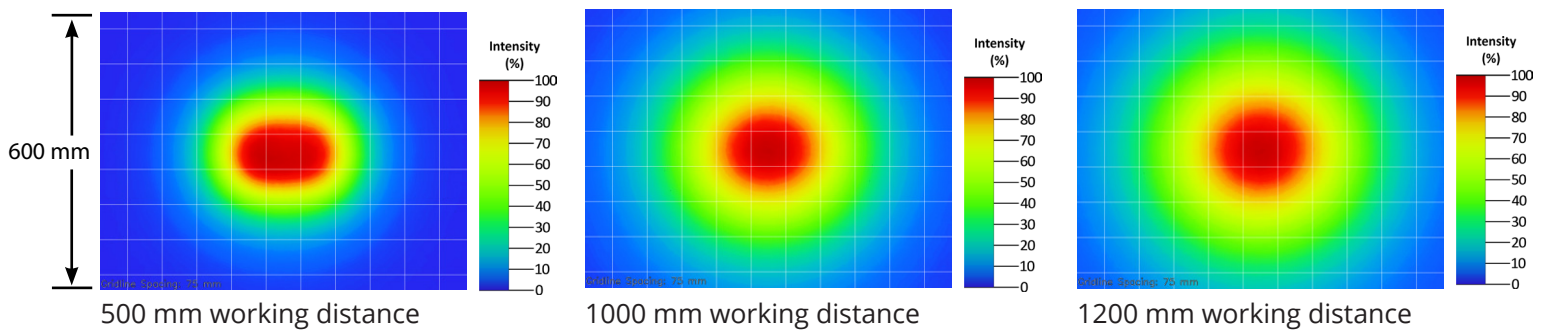



## BEAM PATTERNS (continued)

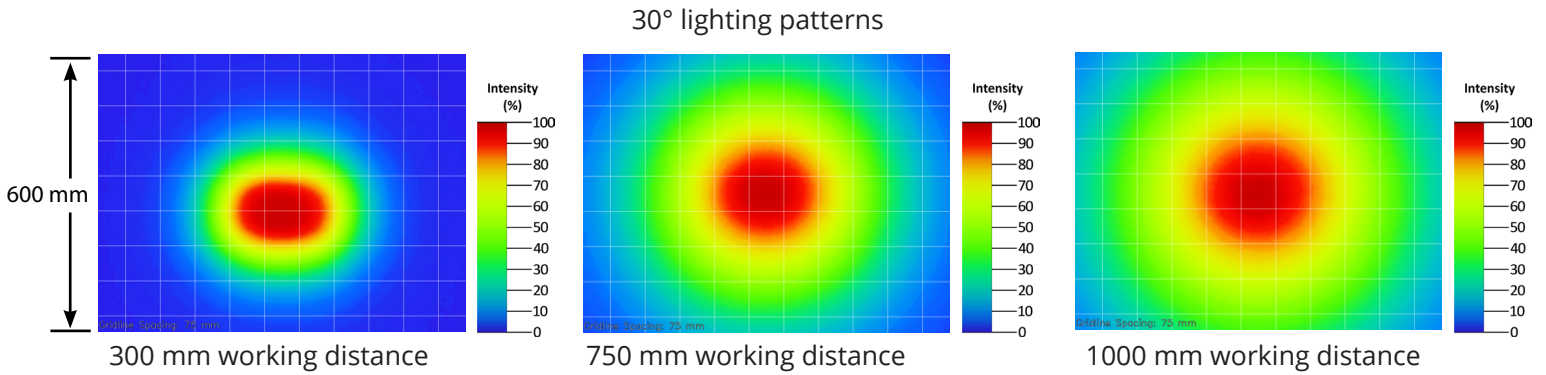

## LENS OPTICS

### NARROW

Narrow, 10° angle-cone lenses create a narrow beam of illumination and are used for long working distances.



### WIDE

Wide, 30° angle-cone lenses create the largest area of illumination. They create a floodlight effect and can be used for the shortest working distances.



### NARROW (Standard)

Narrow, 14° angle-cone lenses create are standard. They create a narrow beam of illumination and are used for long working distances.



## MOUNTING

T-Slots are located along the top and bottom of the JWL225-MD.

The JWL225-MD comes with two M8-1.25 x 12 mm screws and two M8 x 1.25 T-nuts.



T-slots for mounting

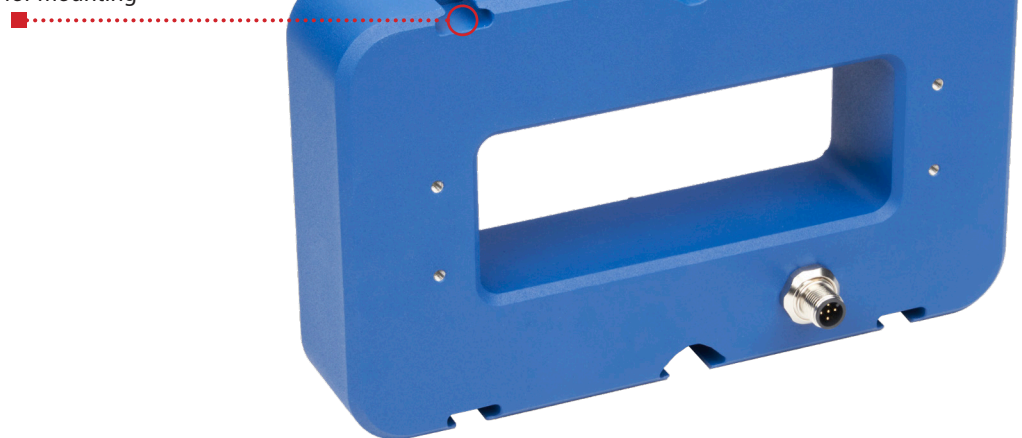

## EYE SAFETY

According to IEC 62471:2006. Full documentation available upon request with purchase of product.

### Notice

**Exempt Group:** No photobiological hazard to eyes or skin even for continuous, unrestricted use. Applicable for wavelengths 625 and 850.

### Caution

**Risk Group 1:** Possibly hazardous optical radiation emitted from this product. Do not stare at operating lamp. May be harmful to eyes. Safe for most applications except prolonged exposure. Applicable for wavelengths 470 and WHI.

## ILLUMINATION

The JWL225-MD works best for:

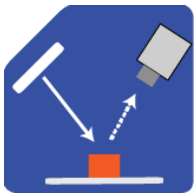

Bright Field

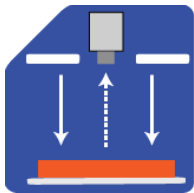

Direct Lighting

## DUTY CYCLE

**This section applies only if light is in OverDrive™ strobe mode.**

The Duty Cycle (D) is related to the Strobe Time (ST) and Rest Time (RT).

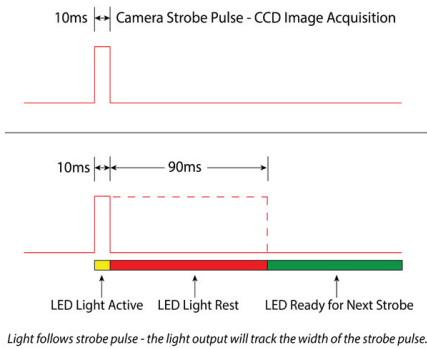

### Calculating Rest Time

$$RT = \frac{ST}{D} - ST$$

RT = Rest Time  
ST = Strobe Time  
D = Duty Cycle

#### Example

$$90 \text{ ms} = \frac{10 \text{ ms}}{.1} - 10 \text{ ms}$$

Rest Time is 90 ms for 10 ms Strobe Time

### Calculating Strobe Rate

$$SR = \frac{D}{ST}$$

SR = Strobe Rate (strokes per second)  
ST = Strobe Time (seconds)  
D = Duty Cycle

#### Example

$$1000 = \frac{0.1}{0.0001}$$

Strobe Rate is 1000 strokes per second

### Calculating Duty Cycle

$$D = ST \times SR$$

SR = Strobe Rate (strokes per second)  
ST = Strobe Time (seconds)  
D = Duty Cycle

#### Example

$$0.1 = 0.0001 \times 1000$$

Duty Cycle is 10% (0.1)

**Maximum Duty Cycle for OverDrive™ light is 7%.**

**Maximum Strobe Frequency is 1/ calculated duty cycle or 4,000 strokes per second, whichever is less.**

## MULTI-DRIVE™

Multi-Drive™ provides both continuous and OverDrive™ modes from a single integrated driver. Users can select the lighting mode via the input wiring configuration. With OverDrive™, the light can be strobed at up to 10 times the intensity\* of continuous mode.

\*See lighting section for more information on this light's OverDrive values.



## SAFESTROBE™

SafeStrobe™ is a unique technology that applies safe working parameters to ensure high current LEDs are not damaged by driving them beyond their limits, such as maximum strobe time or duty cycle. This is especially beneficial for overdriving our high current LEDs.

## SMARTVISIONLINK™

The JWL225-MD is SmartVisionLink™-enabled and is designed so intensity limits can be adjusted using the SmartVisionLink™ app\*.

SmartVisionLink™ provides a way for a light to communicate with an app on a mobile device or tablet. This technology allows users to adjust the intensity limit of the light in both continuous operation and OverDrive™ strobe mode. By connecting the BTM-1000 Bluetooth module to a light that is SmartVisionLink™-enabled, a user can adjust parameters for the light. The SmartVisionLink™ app is available free to download in the Apple App and Google Play Stores.

Visit [SmartVisionLights.com/SmartVisionLink](http://SmartVisionLights.com/SmartVisionLink) for more information.

\*Requires the purchase of the BTM-1000 bluetooth module, sold separately.



## CONNECTING A BTM-1000

The BTM-1000 can be connected directly to a light or attached to a jumper cable that is connected to a light. Once the light's intensity limit is set to a desired level, the BTM-1000 can be removed from the light or cable.

The pigtail end of the BTM-1000 is connected directly to the light or to the cable attached to the light - sold separately.



## PART NUMBER GUIDE

**JWL225-MD** -



Leave blank for Standard (Narrow, 14°)

**N10** = Narrow (10°)

**W30** = Wide (30°)



Leave blank for none

**LPI** = Factory Installed

### Part Number Examples:

**JWL225-MD-625** JWL225-MD, 625 nm Red Wavelength, Standard Lens Configuration

**JWL225-MD-WHI-W30-LPI** JWL225-MD, White Wavelength, Wide Lens, Linear Polarizer

*Additional wavelengths and lens options available upon request.*

*\*For lights with lenses, running in continuous operation while using a linear polarizer with certain wavelengths (e.g., white, blue) may burn the polarizer. Incorrect usage of the polarizer is not covered by warranty.*

## ACCESSORIES

Power Cables	
Lengths	Part Number
5 m	5PM12-5
10 m	5PM12-10
15 m	5PM12-15

Bracket	
Description	Part Number
Mounting Bracket	BKT0031

Mounting Kit	
Description	Part Number
M8-1.25 x12 mm screw	SC0030
M8 x 1.25 T-nut	NU009

Light comes with two screws and two T-nuts.

SmartVisionLink™	
Description	Part Number
Bluetooth Module	BTM-1000



# PRODUCT DRAWINGS

CAD files are available on our website. Drawings are in mm.

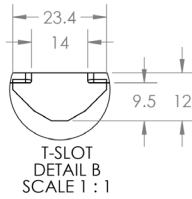
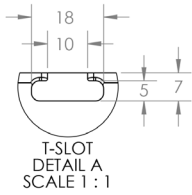
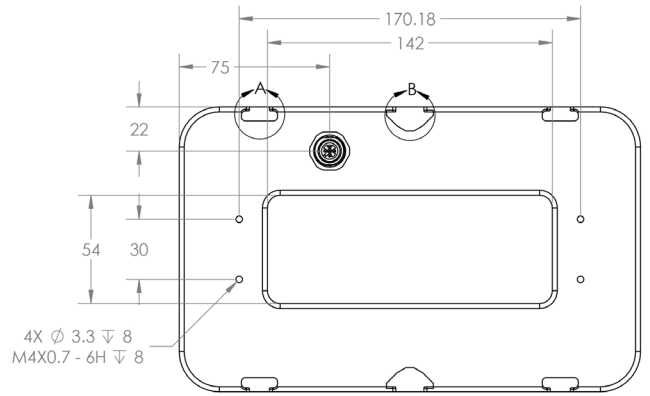
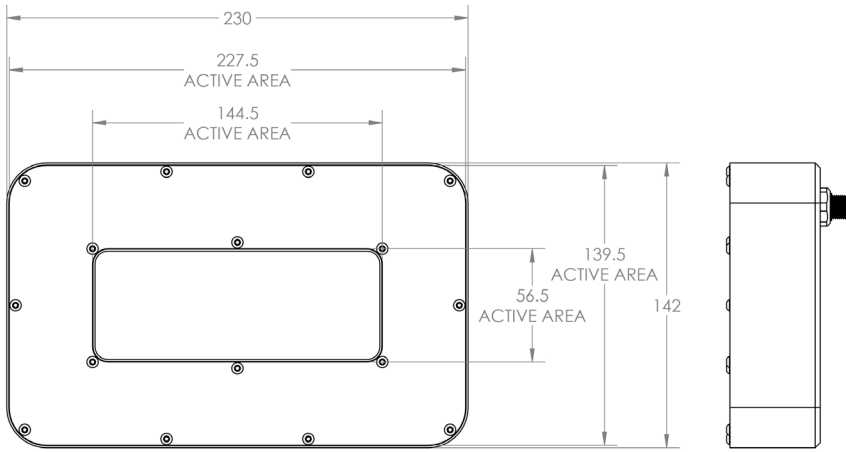
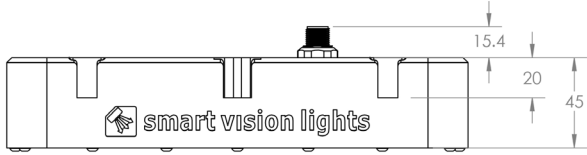

## GLOSSARY

This glossary covers all Smart Vision Lights product families; some content in this section may not apply to this specific light.

### TERMINOLOGY

**Continuous Operation** The light stays on continuously.

**OverDrive™** Integrated driver that produces a high-current strobe to the LEDs to drive them beyond their nominal continuous operation output.

**Multi-Drive™** Integrated driver that combines continuous operation and OverDrive™ strobe mode

**NanoDrive™** Integrated driver that provides fast switching where the light can go from off to on in less than 500 ns.

**Built-in Driver** The driver contained within the light that controls the current to the LEDs and provides PNP, NPN, and analog dimming controls.

**SmartVisionLink™** Integrated feature that enables lighting control through the Bluetooth module and app.

**Camera to Light** Connect the light directly to the camera, without the need for additional controllers or equipment.

**Polarizers** Filters that reduce reflections on specular surfaces.

**Diffusers** Widens the angle of emission by scattering light in all directions.

**Pattern Area Lighting** Modulated lighting pattern placed over a backlight's surface used to enhance defect detection on transparent and glossy surfaces

**SafeStrobe** Limiter to keep the light in safe working parameters.

**Direct Connect** Connect lights in a series without the use of cables.

**Daisy-Chain** Connect lights in a series with the use of cables.

### TYPES OF ILLUMINATION

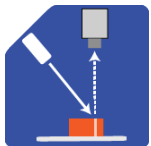

Projector

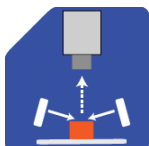

Dark Field

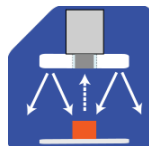

Radial



Bright Field

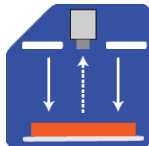

Direct

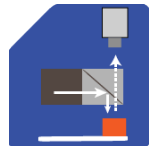

Axial

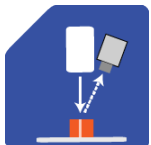

Line

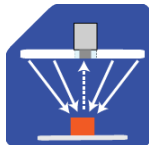

Diffuse Panel

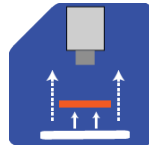

Backlight

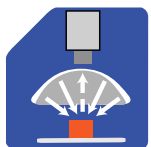

Dome  
"Light Tent"

### COMMON COLOR / WAVELENGTHS LEGEND

Wavelengths options range from 365 nm to 1650 nm.\*  
Additional wavelengths available for many light families.

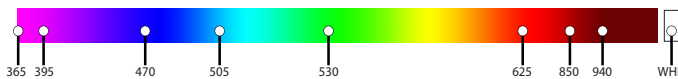

\*See Part Number section for **this light's** available standard wavelengths.



Shortwave Infrared LEDs are available in 1050 nm, 1200 nm, 1300 nm, 1450 nm, 1550 nm, and 1650 nm.\*

\*Check Part Number section to see if **this light** is available in SWIR wavelengths.



ISO 9001:2015 Certified QMS