

ODL300 Linear Light

CONNECT-A-LIGHT | OVERDRIVE™

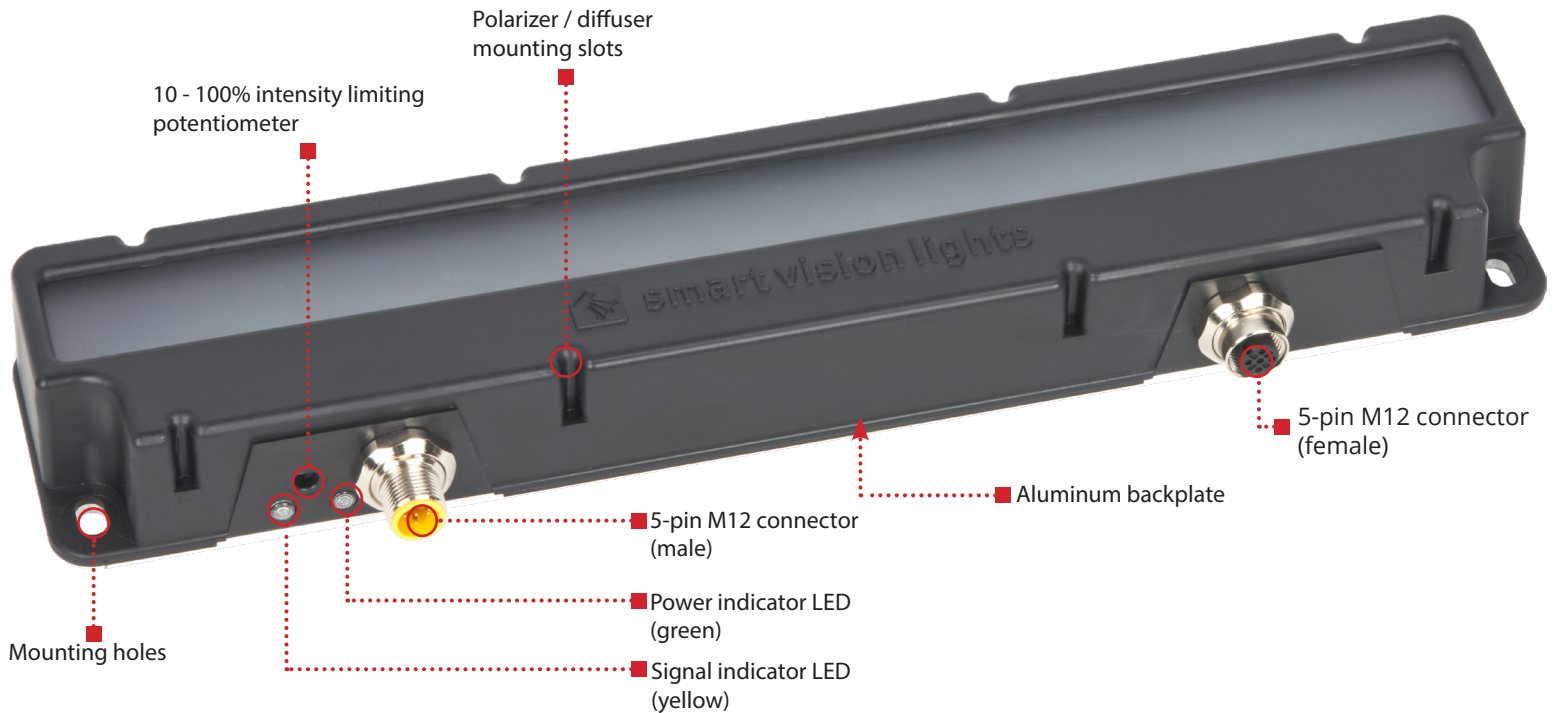

The ODL300 is an OverDrive™ linear light featuring an integrated OverDrive current driver with a lux value of up to 90,000 and a strobe rate of up to 4,000 strobes per second. NPN or PNP triggers can be used to control the strobe rate and duration. Light intensity can be controlled via 1 - 10 VDC analog intensity line or set manually by the intensity limiting potentiometer. The ODL300 can be daisy-chained with up to six lights in series using a standard 5-pin M12 jumper cable.

ODL300 HIGHLIGHTS

Warranty 10 YEAR	Tested IEC 62471	Compliant CE ROHS	Rated IP 50	Connector 5-PIN M12
--------------------------------	--------------------------------	---------------------------------	---------------------------	-----------------------------------

- ✓ Daisy-chain up to six ODL300 linear lights using a standard 5-pin M12 jumper cable
- ✓ High-impact injection molded housing
- ✓ Built-in potentiometer for physical intensity adjustment
- ✓ Up to 4,000 strobes per second
- ✓ OverDrive™ - up to five times brighter than a standard linear connect-a-light



SPECIFICATIONS

Electrical Input	24 VDC +/- 5%
Input Current	Peak 4.6 A during strobe
Input Power	Peak 110 W during strobe
PNP Trigger	2.8 mA @ 4VDC 8.8 mA @ 12VDC 17.6 mA @ 24VDC
NPN Trigger	14.4 mA @ Common (0VDC)
Trigger Input	PNP > +4 VDC (24 VDC max.) to activate or NPN ≥ GND <1VDC to activate (not both)
Strobe Duration	Min. 30 μs Max. 125 ms
Strobe Trigger Latency	6 μs
Strobe Frequency	Max 4 kHz or 1 / Duty Cycle as calculated, whichever is less.*
Duty Cycle	Max. 10%*
Power Indicator	Turns green when powered up
Status Indicators	Strobe indicator will turn red while resting and turn off when ready
Intensity Limit	270° turn-pot. Turn clockwise to increase intensity limit.
Analog Intensity	The output is adjustable from 10% - 100% of intensity limit by a 1 - 10 VDC signal. Jumpering pin 5 to pin 1 will provide maximum intensity.
Connection	5-pin M12 connector
Operating Temperature	-10° to 40° C (14° to 104° F) RH max 80% non-condensing humidity
Storage Temperature	-20° to 70° C (-4° to 158° F) RH max 80% non-condensing humidity
IP Rating	IP50
Weight	~370 g
Compliances	CE, IEC 62471, RoHS
Warranty	10 years**

*See page 6 for more information

**See SmartVisionLights.com/warranty for details

WIRING CONFIGURATION

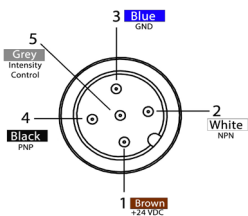

Pins	Function	Signal	Wire Color
1	Power In	+24VDC	BROWN
2	NPN	Sinking Signal	WHITE
3	GND	Ground	BLUE
4	PNP	Sourcing Signal	BLACK
5	OverDrive™ Signal	1-10VDC	GREY*

For maximum intensity, tie pin 5 to pin 1 at +24VDC.

For proper light function, apply either a PNP or NPN signal, not both.

Failure to supply light with correct input current will result in inconsistent lighting behavior.

(see Product Specifications for requirements)

LIGHTING PATTERNS

The ODL300 is recommended to be used at a working distance between 300 mm to 2000 mm. Illuminance values taken on white light - 5700K

Standard (16°) lighting patterns

Illuminance -vs- Working Distance

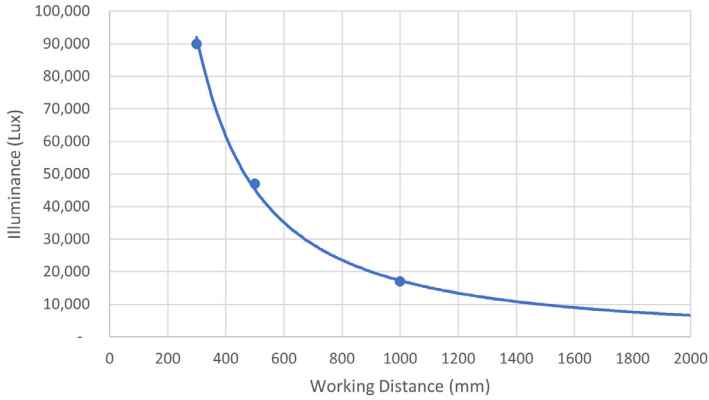

Beam Size at 80% Max Intensity -vs- Working Distance

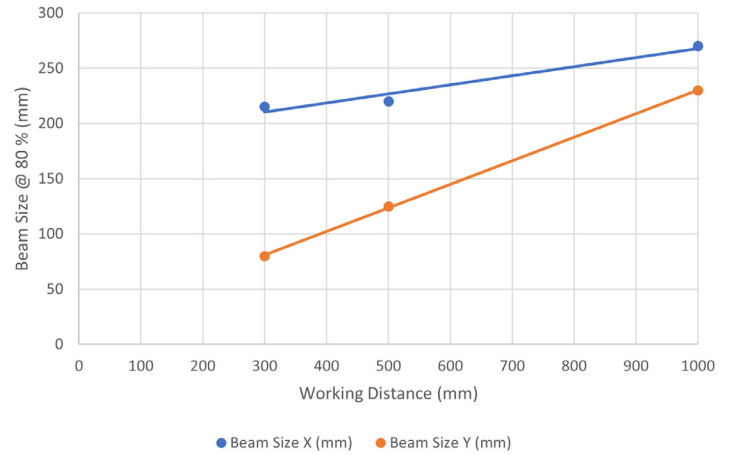

Wide (30°) lighting patterns

Illuminance -vs- Working Distance

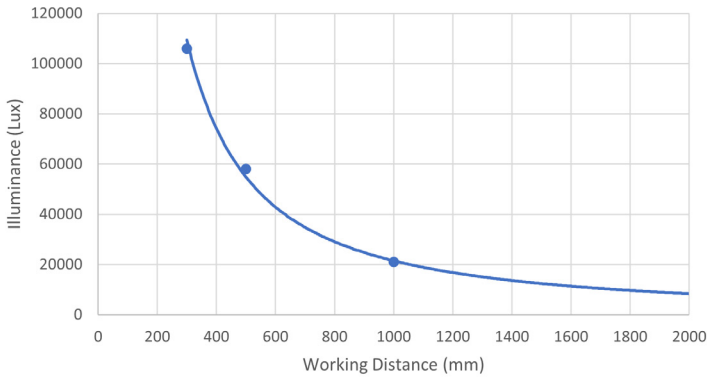

Beam Size at 80% Max Intensity -vs- Working Distance

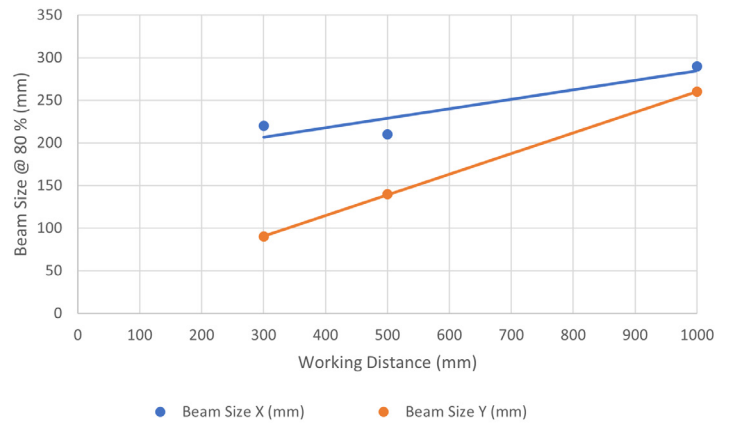

Line (10° x 50°) lighting patterns

Illuminance -vs- Working Distance

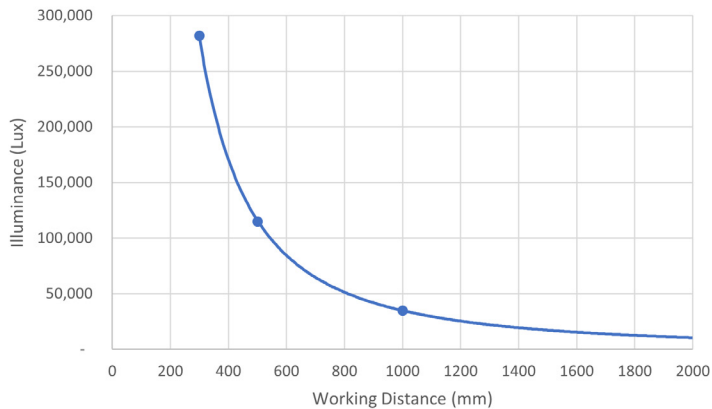

Beam Size at 80% Max Intensity -vs- Working Distance

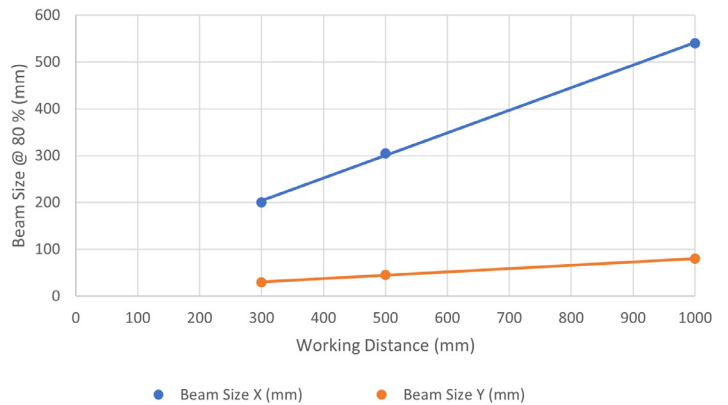

BEAM PATTERNS

The LO300 is recommended to be used at a working distance between 300 mm to 2000 mm. Illuminance values taken on white light - 5700K

Standard (16°) beam patterns

Grid set to 75 mm

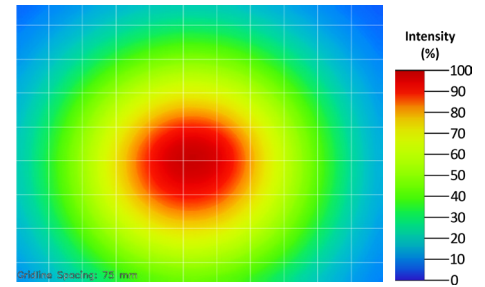
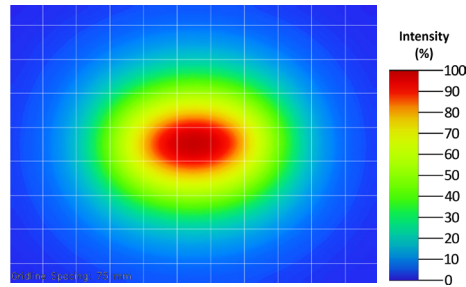
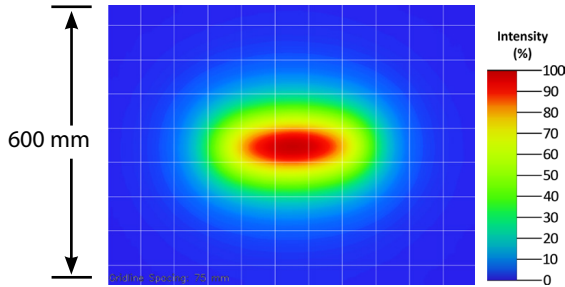

Wide (30°) beam patterns

Grid set to 75 mm

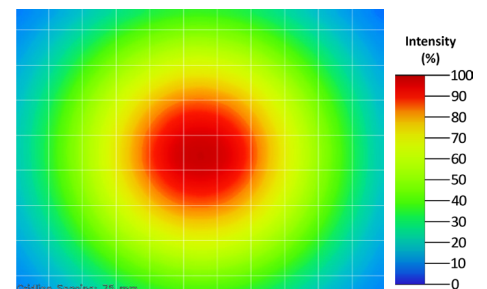
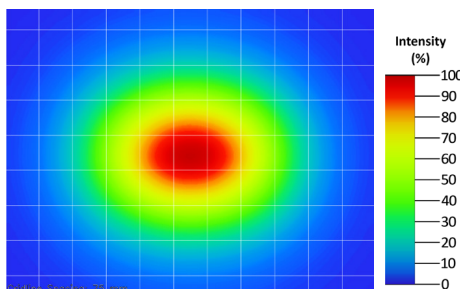
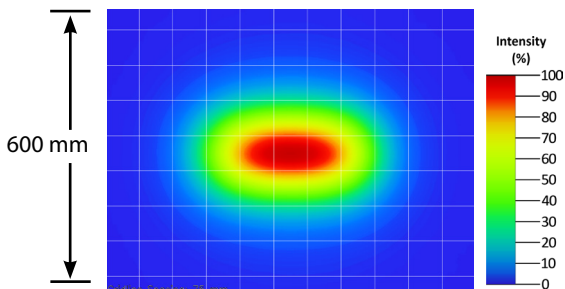

Line (10° x 50°) beam patterns

Grid set to 75 mm

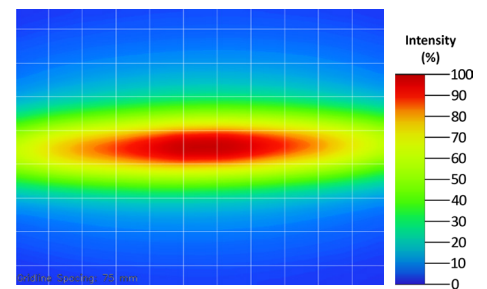
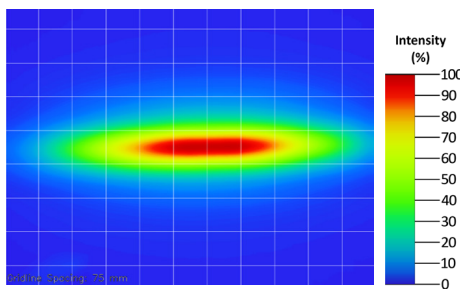
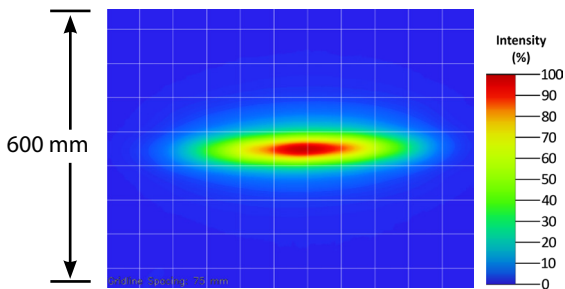

LENS OPTICS

NARROW (Standard)

Narrow, 16° angle-cone lenses are standard. Standard lenses create a narrow beam of illumination and are used for long working distances.



LINE

Line, with a 10° width and a 50° fan angle, projects a thin, narrow beam of illumination.

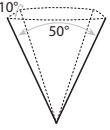

WIDE

Wide, 30° angle-cone lenses create a large area of illumination. They create a floodlight effect and can be used for short working distances.



DAISY-CHAIN LIGHTS

ODL300 Series of lights requires the use of a standard 5-pin M12 jumper cable to effectively parallel up to six ODL300 lights.

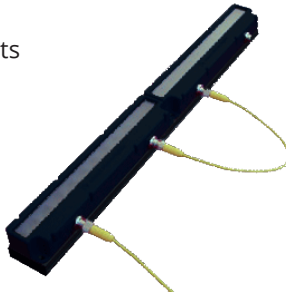

There is consistent spacing between LEDs as lights are connected together.

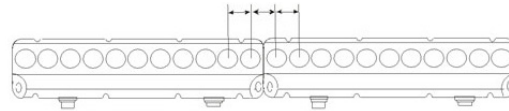

EYE SAFETY

According to IEC 62471:2006. Full documentation available upon request with purchase of product.

Notice

Exempt Group: No photobiological hazard to eyes or skin even for continuous, unrestricted use. Applicable for wavelengths 625, 850, and 940.

Caution

Risk Group 1: Possibly hazardous optical radiation emitted from this product. Do not stare at operating lamp. May be harmful to eyes. Safe for most applications except prolonged exposure. Applicable for wavelengths 470, 505, 530, and WHI.

Warning

Risk Group 2: UV emitted from this product. Eye or skin irritation may result from exposure. Use appropriate shielding. Applicable for wavelength 365 and 395.

ILLUMINATION

The ODL300 works best for:

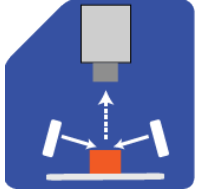

Dark Field

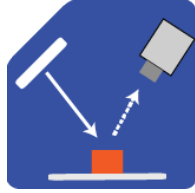

Bright Field

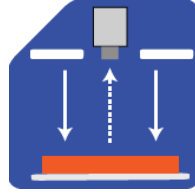

Direct Lighting

DUTY CYCLE

This section applies only if light is in OverDrive™ strobe mode.

The Duty Cycle (D) is related to the Strobe Time (ST) and Rest Time (RT).

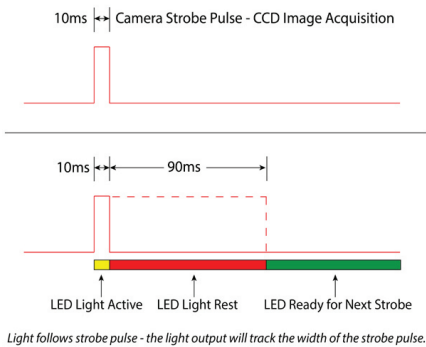

Calculating Rest Time

$$RT = \frac{ST}{D} - ST$$

RT = Rest Time
ST = Strobe Time
D = Duty Cycle

Example

$$90 \text{ ms} = \frac{10 \text{ ms}}{.1} - 10 \text{ ms}$$

Rest Time is 90 ms for 10 ms Strobe Time

Calculating Strobe Rate

$$SR = \frac{D}{ST}$$

SR = Strobe Rate (strokes per second)
ST = Strobe Time (seconds)
D = Duty Cycle

Example

$$1000 = \frac{0.1}{0.0001}$$

Strobe Rate is 1000 strokes per second

Calculating Duty Cycle

$$D = ST \times SR$$

SR = Strobe Rate (strokes per second)
ST = Strobe Time (seconds)
D = Duty Cycle

Example

$$0.1 = 0.0001 \times 1000$$

Duty Cycle is 10% (0.1)

Maximum Duty Cycle for OverDrive™ light is 10% (0.1)

Maximum Strobe Frequency is 1/ calculated duty cycle or 4,000 strokes per second, whichever is less.

OVERDRIVE™

OverDrive is an integrated strobe driver that provides up to 10 times the intensity of a standard driver. Utilizing SafeStrobe™ technology, an OverDrive light can be safely strobed up to 4,000 times a second.



SAFESTROBE™

SafeStrobe™ is a unique technology that applies safe working parameters to ensure high current LEDs are not damaged by driving them beyond their limits, such as maximum strobe time or duty cycle. This is especially beneficial for overdriving our high current LEDs.

PART NUMBER GUIDE

ODL300 -



COLOR:



LENS:

Leave blank for Standard (Narrow)
W = Wide (30°)
L = Line (10° x 50°)



LINEAR POLARIZER:

Leave blank for none
LPI = Factory Installed

Part Number Examples:

- ODL300-625** ODL300, 625 nm Wavelength, Standard Lens
- ODL300-WHI-L** ODL300, White, Line Lens
- ODL300-470-W-LPI** ODL300, 470 nm Blue Wavelength, with Linear Polarizer Installed

*Line lens optic not available for UV wavelengths.
Additional wavelengths and lens options available upon request.*

ACCESSORIES

Power Cables

Length	Part Number
5 m	5PM12-5
10 m	5PM12-10
15 m	5PM12-15

Jumper Cables (Daisy Chain)

Length	Part Number
300 mm	5PM12-J300
1000 mm	5PM12-J1000
2000 mm	5PM12-J2000

Mount

Description	Part Number
3-Axis Pan and Tilt Mount	PB300-M5

Mounting Rails

Length	Part Number
300 mm	LEXT300
600 mm	LEXT600
900 mm	LEXT900
1200 mm	LEXT1200

Custom sizes available

Diffuser

Description	Part Number
Diffuser Kit	L300-DKIT

Linear Polarizer

Description	Part Number
Linear Polarizer Kit	L300-LP

Power Adapters *

Description	Part Number
AC, 24 V, 1.7 A	T1 Power Supply
24 V DC, 9 A / AC input	T2 Power Supply

* European Versions Available (Add "-EURO" to end of T1. Ex: T1-EURO Power Supply.)

PRODUCT DRAWINGS

*CAD files available on our website
Drawings are in mm

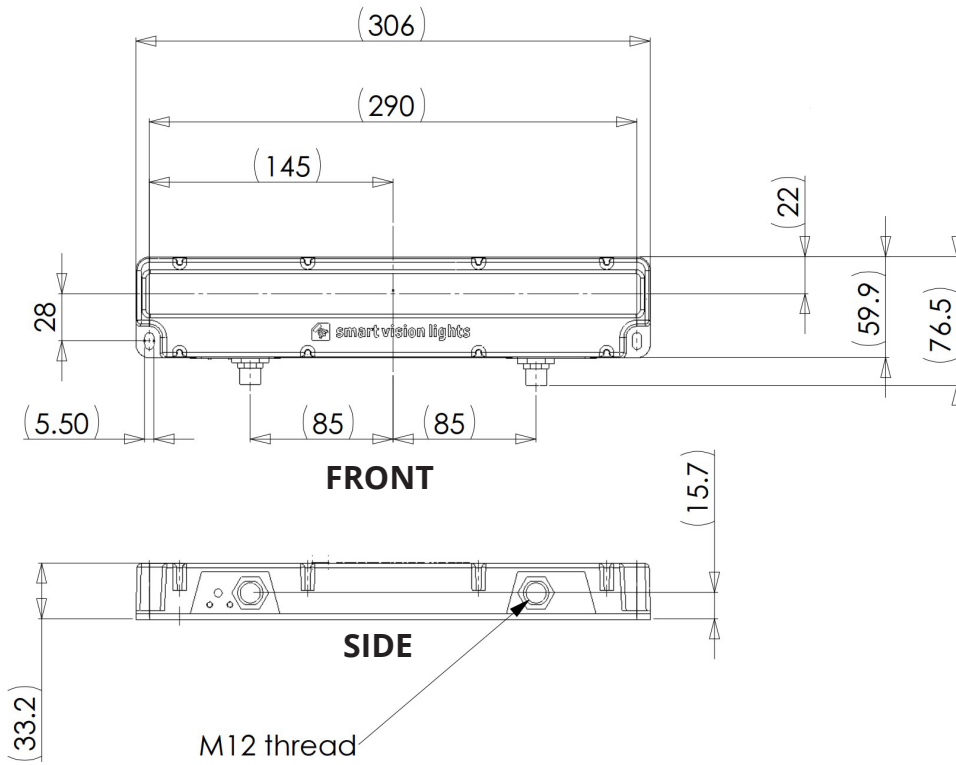

GLOSSARY

This glossary covers all Smart Vision Lights product families; some content in this section may not apply to this specific light.

TERMINOLOGY

OverDrive™ Light includes an integrated high-pulse driver for complete LED light control.

Continuous Operation Light stays on continuously.

Multi-Drive™ Combines continuous operation and OverDrive™ strobe (high-pulse operation) mode into one easy-to-use light.

Built-in Driver The built-in driver allows full function without the need of an external controller.

Camera to Light Connect the light directly to the camera, without the need for additional controllers or equipment.

Polarizers Filters that reduce reflections on specular surfaces.

Diffusers Used to widen the angle of light emission, reduce reflections, and increase uniformity.

TYPES OF ILLUMINATION

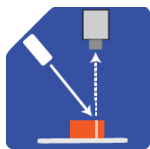

Projector

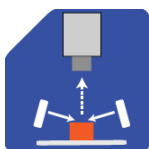

Dark Field

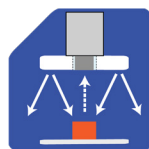

Radial



Bright Field

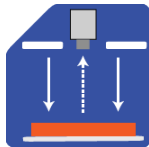

Direct

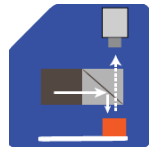

Axial

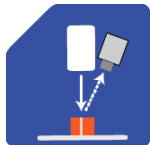

Line

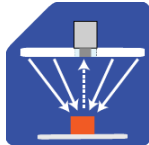

Diffuse Panel

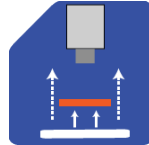

Backlight

COMMON COLOR/WAVELENGTHS LEGEND

Wavelengths options range from 365 nm to 1650 nm.*
Additional wavelengths available for many light families.

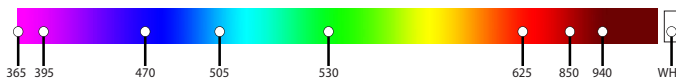

*See Part Number section for **this light's** available standard wavelengths.



Shortwave Infrared LEDs are available in 1050 nm, 1200 nm, 1300 nm, 1450 nm, 1550 nm, and 1650 nm.*

*Check Part Number section to see if **this light** is available in SWIR wavelengths.



ISO 9001:2015 Certified QMS